

Operating instruction – Spindle lifting system SL/SK/SM 14xx Compact

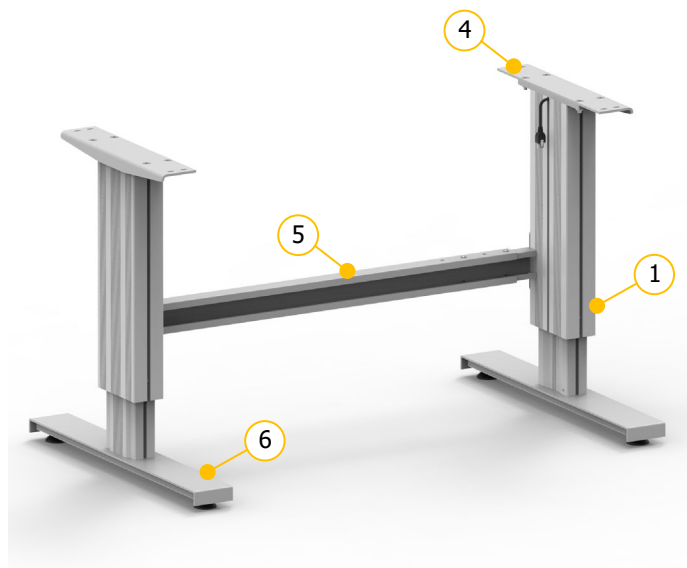

It is essential to read this operating instruction thoroughly before commissioning the system. The manual must be kept in close proximity to the system for future reference.

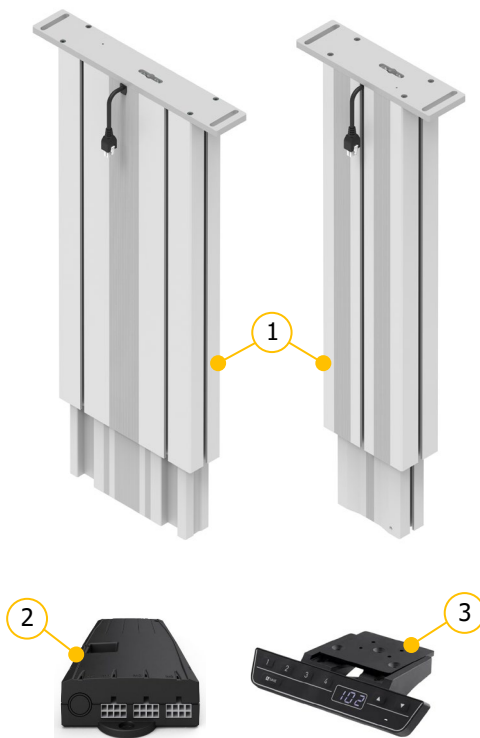

- ① Spindle lifting column of Type SL, SK or SM
- ② Control box Compact-3-eco
- ③ Hand switch Memory

- Example of a frame with two lifting columns:
- ④ Table plate support
 - ⑤ Cross bar
 - ⑥ Table feet

Errors and technical changes reserved.

Ergoswiss AG does not assume any liability for operating errors or using the products outside of the intended purpose use.

At the time of delivery Ergoswiss AG will replace or repair defect products within accordance with the warranty provisions. In addition, Ergoswiss assumes no other liability.

For your questions and special custom demand Ergoswiss AG will be at your disposal.

Ergoswiss AG
Nöllenstrasse 15
CH-9443 Widnau
Tel.: +41 (0) 71 727 06 70
Fax: +41 (0) 71 727 06 79

info@ergoswiss.com
www.ergoswiss.com

This operating instruction applies to:

Lifting systems SL 14xx, SK 14xx and SK 14xx with control box Compact

Example: Lifting system SL 2440 EU 02 (Article number: 901.20034)

Example: Lifting system SK 2440 EU 02 (Article number: 910.20034)

Example: Lifting system SM 2440 EU 02 (Article number: 902.20034)

	Description	Standard variations
SL	Lifting element type	SL, SK, SM
2440	Number of lifting elements	1, 2
2440	Spindle pitch in mm	4 mm
2440	Stroke length in cm	30 cm, 40 cm
EU	Country specific power cable	EU, CH, US
02	01= Hand switch Up-Down ; 02= Hand switch Memory	02

Frame SL 14xx, SK 14xx and SK 14xx with control box Compact

Bsp.: Frame SL 2440 960-1610 EU 02 (Article number: 901.30058)

Bsp.: Frame SK 2440 960-1610 EU 02 (Article number: 910.30058)

Bsp.: Frame SM 2440 970-1620 EU 02 (Article number: 902.30058)

	Description	Standard variations
SM	Lifting element type	SL, SK, SM
2	Number of lifting elements	1, 2
2440	Spindle pitch in mm	4 mm
2440	Stroke length in cm	30 cm, 40 cm
960-1610	Distance from Center of leg to center of leg	Telescopic cross bar
EU	Country specific power cable	EU, CH, US
02	01= Hand switch Up-Down ; 02= Hand switch Memory	02

Other versions

	Description
ESD	Electrostatic discharge from external profile via inner profile
s01-s99	Special version: adapter plate, table foot, fitting length, color, etc.

Notes over the operating instruction:

Lifting systems from Ergoswiss AG are intended for installation in an overall system (e.g. assembly table) and classified under the category of incomplete machines in accordance with the Machinery Regulation (EU) 2023/1230.

This operating instruction contain information on the commissioning, handling and safety of the lifting system and are aimed at the further- user and manufacturer of the entire system. The further-user of this lifting system is obliged to create an operating manual with all usage information and hazard warnings for the entire system.

The declaration of incorporation is only valid for the Ergoswiss lifting system and not for the overall system created by the further-user.

Table of content

1	Safety requirements	4
1.1	Explanations of the symbols and notes	4
2	System description	5
2.1	General	5
2.2	Intended purpose use	5
2.2.1	General safety instructions	5
2.3	Target group and prior knowledge	6
2.4	Performance characteristics	7
2.4.1	Lifting column SL/SK/SM 14xx	7
2.4.2	Control box Compact-3-eco	8
2.4.3	Hand switch Up/Down and Memory	9
2.4.4	System data	9
3	Mounting instructions	10
3.1	Mounting instructions Lifting column	10
3.2	Mounting instructions Control box	12
3.3	Mounting instructions Hand switch	14
3.3.1	Hand switch Memory	14
3.3.2	Hand switch Up-Down	14
4	Initial operation	15
4.1	Plug detection	15
4.2	Duty cycle monitoring	15
5	Operation with Hand switch Type Memory	16
5.1	Drive Up / Down	16
5.2	Saving and approaching a memory position	16
5.3	Limit the stroke length (Container-Stop/Shelf-Stop)	17
5.3.1	Set stroke length limitation	17
5.3.2	Remove stroke length limitation	17
5.4	Setting the shown height on the display	17
5.5	Changing the displayed unit of measurement (cm/inch) – Reset «S 5»	18
5.6	Restore to factory settings – Factory reset «S 0»	18
5.7	Reference drive – Referencing the end positions – «Long Key Down»	19
6	Operation with Hand switch Type Up-Down	19
6.1	Drive Up / Down	19
7	Synchronous operation of 2, 3 or 4 control boxes	20
7.1	Cable connections	20
7.2	Commissioning the synchronized systems	21
7.3	Operation scenarios – FAQ	21
8	Safety strip – Squeezing protection	22
8.1	Commissioning	22
9	Maintenance and disposal	23
9.1	Maintenance and cleaning	23
9.2	Repairs and spare parts	23
9.3	Disassembly and disposal	23
9.4	Electrical and Electronic Equipment Act	23
9.5	Error codes on the display	24
9.6	Click codes	25
9.7	Trouble-shooting	25
10	Declaration of Incorporation	26

1 Safety requirements

The safety instructions must be paid attention to! If the system is operated improperly or not in accordance with the intended use, there may be a risk to persons and property!

Before installing and operating the lifting system, this operating instruction must be read and understood. The manual must be kept in the close proximity to the system for future reference.

1.1 Explanations of the symbols and notes

The following explanations of symbols and notes must be observed. These are classified according to ISO 3864-2 (ANSI Z535.4).

DANGER



Indicates an imminent danger.
Failure to follow the information will result in death or severe physical injury (disability).

WARNING



Indicates a potentially dangerous situation.
Failure to follow the information will result in death or severe physical injury (disability).

ATTENTION



Indicates a potentially dangerous situation.
Failure to follow the information will result in damage to property and minor or medium physical injuries will result.



NOTE

Indicates general information, useful user tips and work recommendations, which have no impact on the health and safety of staff.

2 System description

2.1 General

The basic functionality of a spindle lifting system SL/SK/SM by Ergoswiss AG is the lifting and lowering of work surfaces, machine parts, profile systems, etc.

An operative spindle lifting System SL/SK/SM consists of a minimum of following components:

- Lifting column SL/SK/SM
- Control box Compact-3-eco
- Hand switch Memory
- Country specific power cable

The lifting column SL/SK/SM consists of two colorless anodized aluminium profiles which are guided with plastic guides. The inner profile is moved by an inline spindle drive. Up to 3 spindle lifting elements can be connected to one control box Compact-3-eco and be operated synchronously.

The intelligent control box Compact-3-eco is equipped with a highly efficient switched-mode power supply (SMPS) and a monitoring software (overload, duty cycle, overheat). Due to the optimised driving comfort, the end positions are gently approached as low-speed zones up to the standstill. Additional functions, such as the synchronisation of two to four control boxes or the connection of safety strips (squeezing protection) can be used.

With the hand switch Memory the lifting system can be operated comfortably, the work surface will be adjusted steplessly in its height.

The current height of the work surface is shown continuously on the display (in cm or inches). In addition, up to four different memory positions can be saved and approached individually. Errors that occur are also shown on the display.

2.2 Intended purpose use

Scope of application	NOT scope of application
<ul style="list-style-type: none"> → Height adjustment of worktops → Height adjustment of machine parts → Height adjustment of profile systems → ... the list is not exhaustive 	<ul style="list-style-type: none"> → Clamping tool → Press (or counterhold for press) → Passenger transport → Security component → ... the list is not exhaustive

2.2.1 General safety instructions

ATTENTION	
	<p>The safety instructions must be paid attention to! If the system is operated improperly or not in accordance with the intended use, there may be a risk to persons and property!</p>

The lifting system may be used if:

- it is located in closed rooms, in a dry and non-explosive environment.
- the ambient temperature is between +10 °C and +40 °C.
- the relative humidity range is between 30% and 70% (non-condensing).
- there are no strong electromagnetic fields nearby.
- This device can be used by children aged 8 and over and by persons with reduced physical, sensory or mental abilities or lack of experience and knowledge if they are supervised or have been instructed in the safe use of the device and the resulting dangers to understand.

The lifting system must not be:

- operated outside of the performance data (max. tensile, compressive, bending moment loads).
- subjected to impulse, impact and impact forces (e.g. setting down loads).
- operated with an incorrect mains voltage! Adhere to the type plate of the control box!
- designed for continuous operation (below the duty cycle ratio of 2/18).
- operated on unstable or sloping ground.
- operated with impermissible or non-designated components.
(e.g. different types of lifting elements; replacement of the control (control software))
- operated with damaged components.
- opened, reworked or rebuilt.
- operated if the power cable is not freely accessible. Disconnect the power cord in the event of a fault.
- Children must not play with the device. Cleaning and user maintenance shall not be made by children without supervision.

When installing and operating the lifting system, the intended use of the entire system must be adhered to. Commissioning is prohibited until the entire system complies with the provisions of the Machinery Regulation (EU) 2023/1230. For this purpose, it is essential to perform a risk analysis, so that possible residual hazards can be reacted to (e.g. through constructive measures or through instructions in the operating instructions and/or through safety indication on the system). In the event of improper use, the liability of Ergoswiss AG and the general operating permit for the lifting system will expire.

2.3 Target group and prior knowledge

Before installing and operating the lifting system, this operating instruction must be read and understood. The manual must be kept in close proximity to the system for future reference.

This operating instruction addresses the following groups of people:

The **manufacturer of the overall system** who integrates this lifting system into an overall system and integrates these operating instructions into the operating instructions for the overall system.

The **commissioning personnel** who install the lifting system in a workplace, a machine, etc. and put it into operation. For commissioning basic mechanical and electrical knowledge are required.

2.4 Performance characteristics

2.4.1 Lifting column SL/SK/SM 14xx

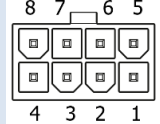
	Lifting column SL/SK 14xx	Lifting column SM 14xx								
Cross-section	260 x 60 mm (10.23" x 2.36")	150 x 70 mm (5.91" x 2.76")								
Standard stroke length	300, 400 mm (12", 16")									
Installation length	Stroke length + 230 mm (9.06") Lower block position: Stroke length + 227 mm (8.94")									
Weight	SL 1430 = 9.5 kg (20.9 lbs) SL 1440 = 10.9 kg (24.0 lbs) SK 1430 = 9.9 kg (21.8 lbs) SK 1440 = 11.3 kg (24.9 lbs)	SM 1430 = 8.1 kg (17.9 lbs) SM 1440 = 9.2 kg (20.3 lbs)								
Max. allowed pressure load	2'000 N (450 lbf)									
Max. allowed tensile load	F _{Tensile stat.} 500 N (112 lbf) ; F _{Tensile dyn.} 50 N (11 lbf) ①									
Power consumption	4 A									
Voltage	24 V									
Lifting speed	12 mm/s (0.47"/s)									
Continuous noise level	< 60 dBA									
Protection class (DIN EN 60529)	IP 30									
Electrical connection	Molex MiniFit Plug 8 Pin Cable length 1'800 mm (71")	 <table border="0"> <tr> <td>1 Motor +</td> <td>5 Pulse 2</td> </tr> <tr> <td>2 ES</td> <td>6 SYN</td> </tr> <tr> <td>3 5V Hall Sensor</td> <td>7 GND Hall Sensor</td> </tr> <tr> <td>4 Pulse 1</td> <td>8 Motor -</td> </tr> </table>	1 Motor +	5 Pulse 2	2 ES	6 SYN	3 5V Hall Sensor	7 GND Hall Sensor	4 Pulse 1	8 Motor -
1 Motor +	5 Pulse 2									
2 ES	6 SYN									
3 5V Hall Sensor	7 GND Hall Sensor									
4 Pulse 1	8 Motor -									
End switch	No (reading encoder)									
Tested product life span	10'000 double strokes, with 400 mm (16") stroke length, 2'000 N (450 lbf) pressure load, duty cycle 2/18 ②									

① stat. = during standstill; dyn. = during stroke movement

② Duty Cycle 2/18; operating max. 2 min, pause 18 min

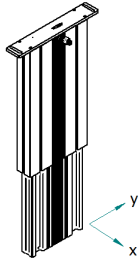
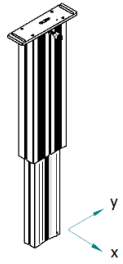
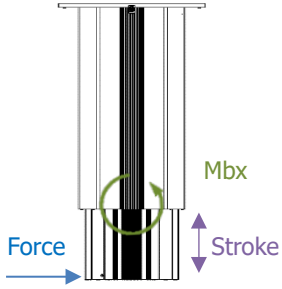
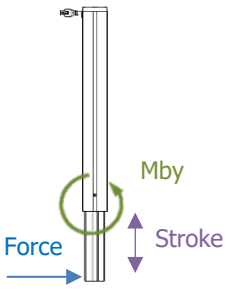
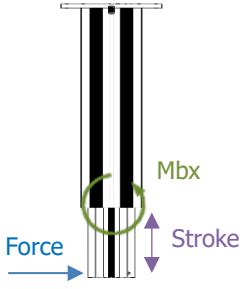
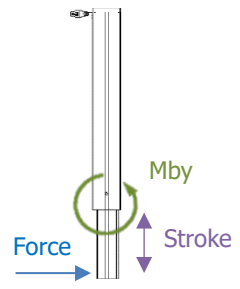
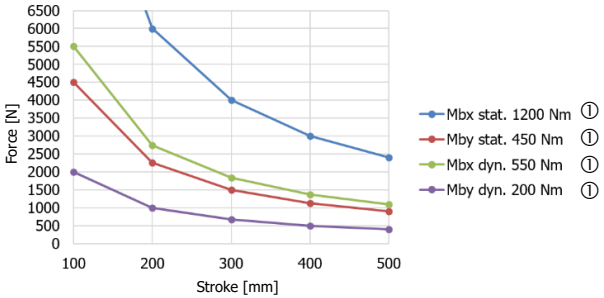
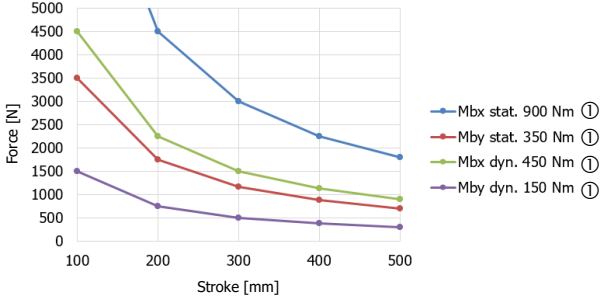
Max. allowed bending moment Lifting column SL/SK		Max. allowed bending moment Lifting column SM	
	<p>Mbx stat. ① 1'200 Nm (885 lbf-ft)</p> <p>Mby stat. ① 450 Nm (332 lbf-ft)</p> <p>Mbx dyn. ① 550 Nm (406 lbf-ft)</p> <p>Mby dyn. ① 200 Nm (148 lbf-ft)</p>		<p>Mbx stat. ① 900 Nm (664 lbf-ft)</p> <p>Mby stat. ① 350 Nm (258 lbf-ft)</p> <p>Mbx dyn. ① 450 Nm (332 lbf-ft)</p> <p>Mby dyn. ① 150 Nm (111 lbf-ft)</p>
			
Mbx = force x stroke	Mby = force x stroke	Mbx = force x stroke	Mby = force x stroke
<p>Bending moment of Lifting column SL/SK</p>  <p>Force [N]</p> <p>Stroke [mm]</p> <ul style="list-style-type: none"> Mbx stat. 1200 Nm ① Mby stat. 450 Nm ① Mbx dyn. 550 Nm ① Mby dyn. 200 Nm ① 		<p>Bending moment of Lifting column SM</p>  <p>Force [N]</p> <p>Stroke [mm]</p> <ul style="list-style-type: none"> Mbx stat. 900 Nm ① Mby stat. 350 Nm ① Mbx dyn. 450 Nm ① Mby dyn. 150 Nm ① 	

① stat. = during standstill; dyn. = during stroke movement

2.4.2 Control box Compact-3-eco

Dimensions (L x W x H)	264 x 103 x 37 mm (10.39" x 4.06" x 1.46")
Weight	0.55 kg (1.2 lbs)
Supply voltage	EU: 207 – 253 V 50 – 60 Hz US: 90 – 127 V 50 – 60 Hz
Primary standby power	≤0.3 W
Power	360 VA ; 15 A @ 24 V DC
Protection class (DIN EN 60529)	IP 20
Performance Level (DIN EN 13849-1)	PL b

2.4.3 Hand switch Up/Down and Memory

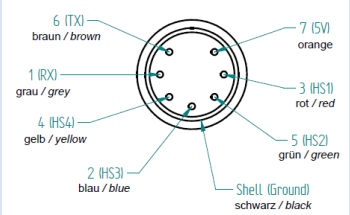
Electrical connection	Plug DIN 45329 Cable length: 1.8 m (71")	
Supply voltage	5 VDC ± 10 %	
Power consumption (average)	50 mA	
Protection class (DIN EN 60529)	IP 30	

2.4.4 System data

# Lifting elements	Max. system load [kg] (lbs)	Stroke length [mm] (in)	Lifting element Type	Control box Compact-3-eco		Lifting speed	② Duty cycle [On/Off]
				230 V	110 V		
1	200 (440)	300 (12")	① 1430	V501	V551	12 mm/s (0.47"/s)	2/18 min
		400 (16")	① 1440	V500	V550		
2	400 (880)	300 (12")	① 1430	V501	V551		
		400 (16")	① 1440	V500	V550		
3	400 (880)	300 (12")	① 1430	V501	V551		
		400 (16")	① 1440	V500	V550		

① Lifting column SL, SK oder SM

② Duty cycle 2/18; operating max. 2 min, pause 18 min

NOTE



The lifting system can be subjected to uneven loads as long ...

- the max. load on the single lifting element is not exceeded,
- the max. bending torque of the lifting element is not exceeded,
- the entire system is located on sufficient safe ground

... and the entire plant has been constructed in accordance with the provisions of the mechanical equilibrium. → Conducting a risk analysis

ATTENTION



High pulse / impact forces due to the discontinuation of loads are not allowed.
(e.g. discontinuation of loads in feed with crane or forklift)

3 Mounting instructions

3.1 Mounting instructions Lifting column



NOTE

The lifting system must be mounted in such a way, that driving to the lower position with all lifting elements is possible at any time.

Otherwise, no initial operating and reset of the system can be carried out.

Mounting on top

Adaptor plate with slot hole
(Screw size M8)

Motor cable 1'800 mm (71")

With up to 5x Motor extension cable of 1'200 mm (47")
can be extended up to 7'800 mm (307")

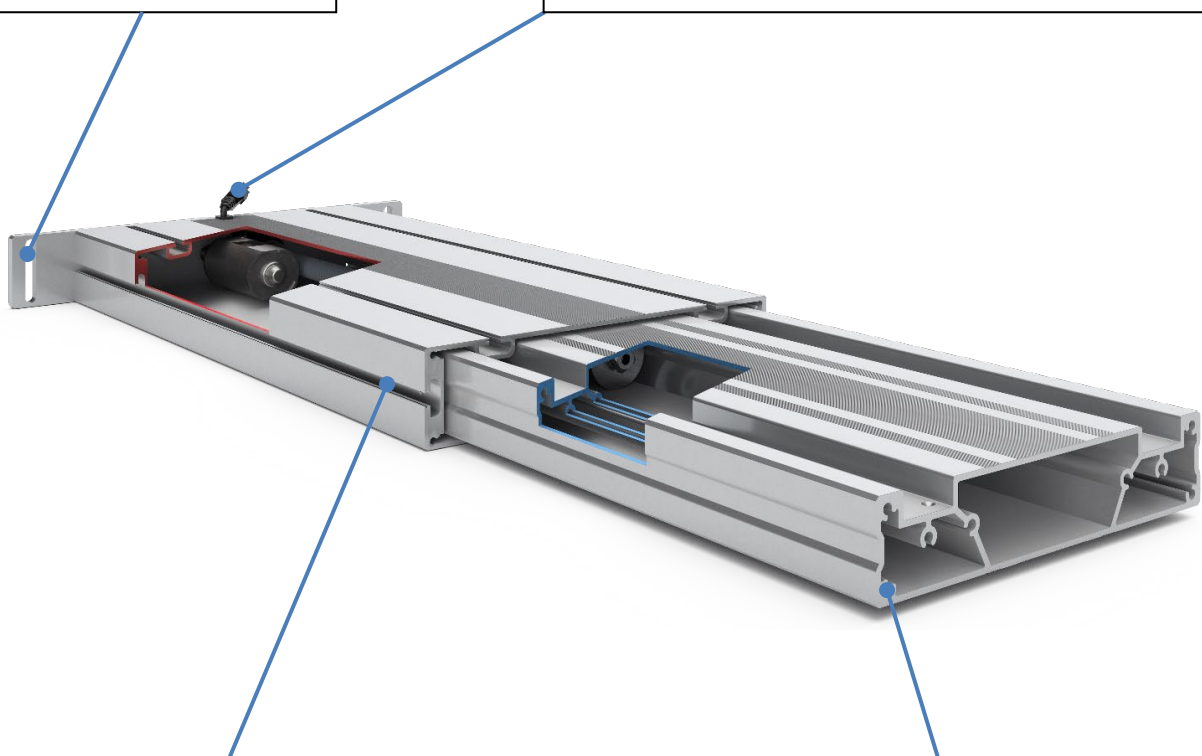

Mounting on T-slot (Cross bar)

Outer profile with T-slots

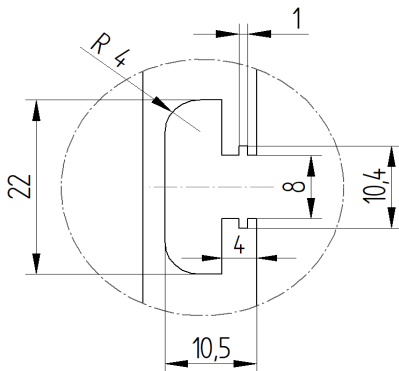

Mounting at bottom

Inner profile
4x Screw M6x20 self-tapping
(included in scope of delivery)

Lifting column Type SL/SK	<p>Adaptor plate (Top)</p> <p>2x Slot hole → for screw size M8</p>	<p style="text-align: right;"><i>(drawing in mm)</i></p>
	<p>Inner profile (Bottom)</p> <p>4x Through hole → for screw size M6 (Ø5.3) (Ø0.2") → Torque max. 6 Nm (4.4 lbf.ft) → Screw-in depth mind. 15 mm (0.6")</p> <p><i>4x Screw M6x20 self-tapping included in the scope of delivery</i></p>	<p style="text-align: right;"><i>(drawing in mm)</i></p>
Lifting column Type SM	<p>Adaptor plate (Top)</p> <p>2x Slot hole → for screw size M8</p>	<p style="text-align: right;"><i>(drawing in mm)</i></p>
	<p>Inner profile (Bottom)</p> <p>4x Through hole → for screw size M6 (Ø5.3) (Ø0.2") → Torque max. 6 Nm (4.4 lbf.ft) → Screw-in depth mind. 15 mm (0.6")</p> <p><i>4x Screw M6x20 self-tapping included in the scope of delivery</i></p>	<p style="text-align: right;"><i>(drawing in mm)</i></p>

3.2 Mounting instructions Control box

Mounting of the control box underneath a table top:

ATTENTION



During mounting of the control box the power cable needs to be disconnected from the mains!

1. Place the control box to the desired location and mark the drill holes with a pen.

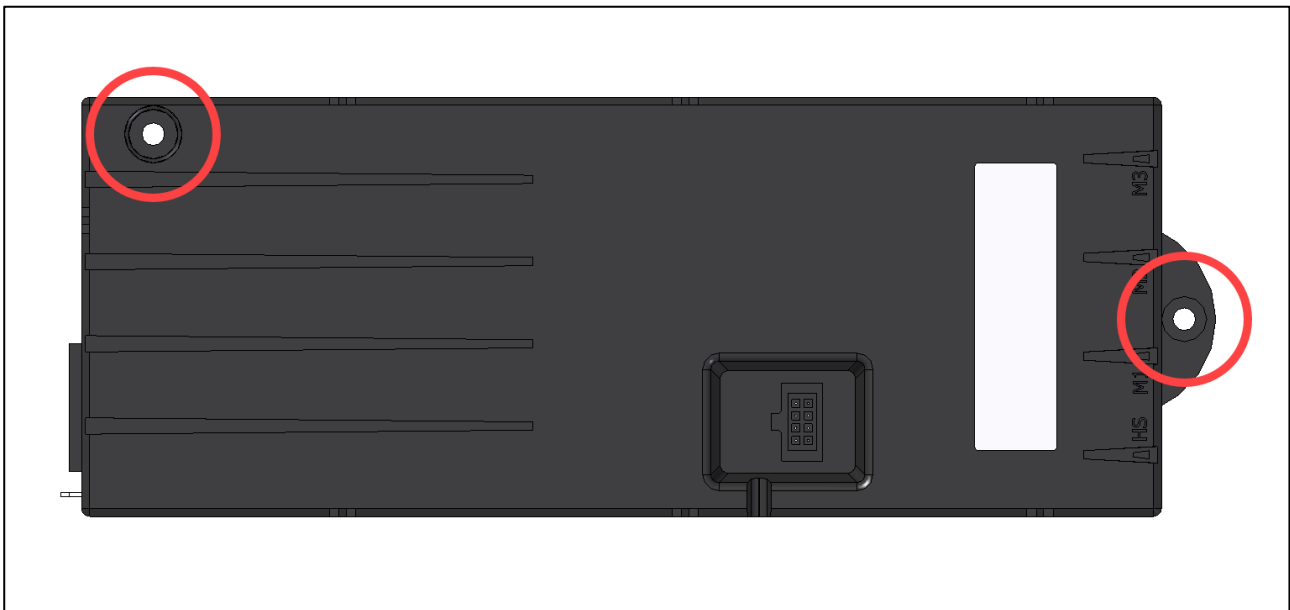

2. Pre-drill 2 holes (\varnothing 3 mm / 0.12").
Be careful not to drill through the table top!
3. Mount the control box with 2 screws.
(e.g.: Button head screw DIN 7981-C, \varnothing 4.8 mm (0.19"), head- \varnothing 9.5 mm / 0.37")



NOTE

When tightening the screws do not exceed a maximum torque of 2 Nm (1.5 lbf.ft)!



NOTE

The motor cable has a length of 1'800 mm (71"). If needed, up to 5 motor extension cables can be connected. They have a length of 1'200 mm (47") each.
→ 124.00137 – Extension cable Motor SCT/Compact 1.2m



NOTE

The cable of the hand switch has a length of 1'800 mm (71"). If needed it can be expanded with up to 3 extension cables. They have a length of 1'000 mm (39") each.
→ 124.00071 – Extension cable Hand switch Compact 1m

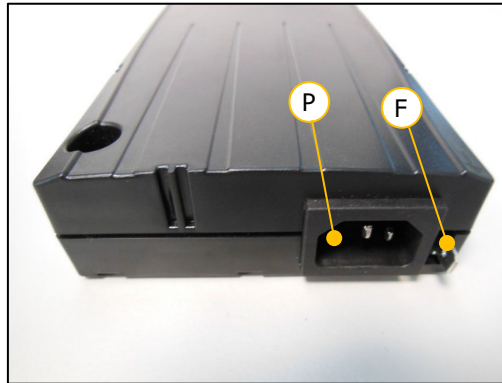
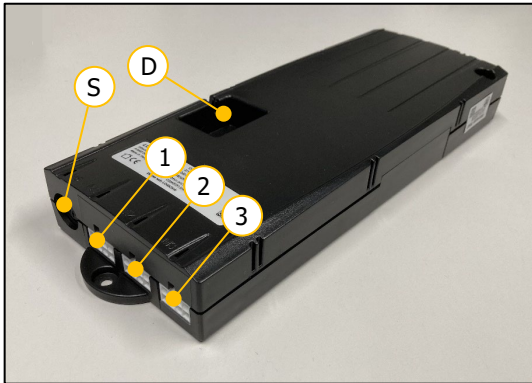

- ① Motor socket 1 (M1)
- ② Motor socket 2 (M2)
- ③ Motor socket 3 (M3)
- S Socket for Hand switch

- D Connection for Safety strip or Sync cable
- P Power socket
- F Connection for functional grounding (e.g. ESD)

ATTENTION



Connecting homemade products to the control box is prohibited!
Only use supplied components.

4. Connect the motor cables to the lifting columns.
5. Connect the motor cables to the control box in the correct order from **M1** to **M3**.
(Automatic plug detection on all sockets)
6. Connect the hand switch to the control box.
If necessary, optional components can now be connected (e.g. safety strips, sync cable).
7. Connect the power cable to the control box.

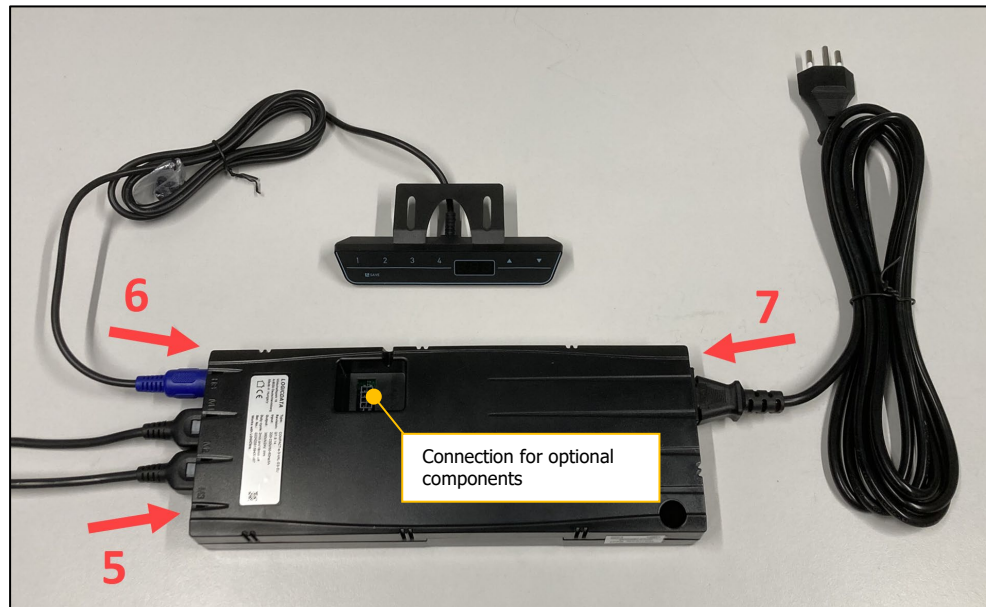

NOTE

- Before connecting the power cable to the mains the following must be verified:
- Does the mains voltage correspond to the value on the name plate of the control box?
 - Are the plugs of the motor cable connected to the correct sockets (**M1**, **M2**, **M3**)?
 - Is the entire lifting system assembled according to the assembly instructions?

8. Connect power cable to the mains. (Click sound → ready for initial operation)

3.3 Mounting instructions Hand switch

3.3.1 Hand switch Memory

1. Position the hand switch underneath the table plate. The control panel must overhang below the work surface!
2. Fasten the hand switch using the mounting screws. Be careful not to drill through the table top!

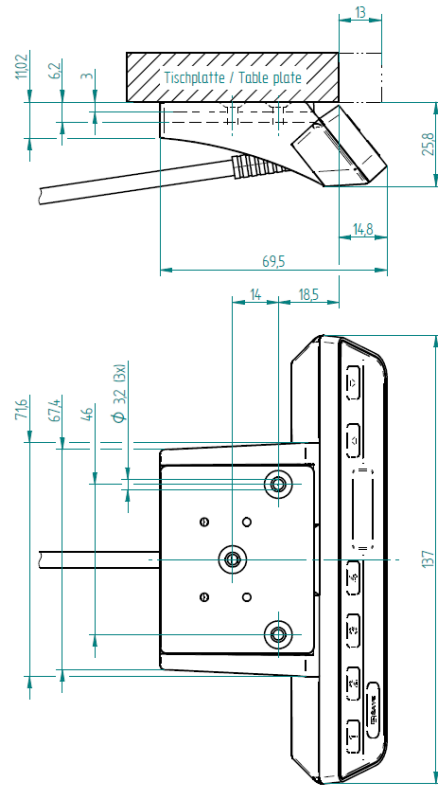

3.3.2 Hand switch Up-Down

1. Position the hand switch underneath the table plate. The control panel must overhang below the work surface!
2. Fasten the hand switch using the mounting screws. Be careful not to drill through the table top!

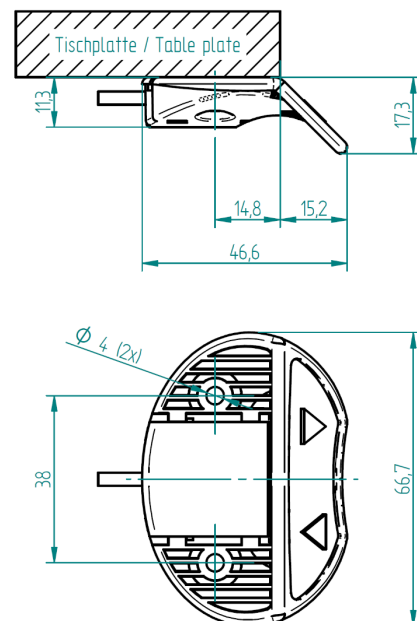

4 Initial operation

ATTENTION



Danger of squeezing during height adjustment!

ATTENTION



It must be possible to fully retract the lifting element to its lower block position at any time (also in the operating state).
If the lifting element cannot retract completely and hits a stop before it reached its lower block position, the zero position is set incorrectly. This leads to a collision when moving up to the upper block position.

ATTENTION





The system may only be fully loaded after the initial operation has been completed.
During the initial operation, the lifting system may be loaded with max. 50% of the system load.



NOTE

During the initial operation, the lifting system drives with half the speed.

1. Keep the button  pressed to drive to the lower block position.
The system moves downwards at half speed. Upward movement is disabled.
2. After reaching the block position, let go of the button .
The control box will give a click sound and the system will drive out a few millimeters.

After reaching the block position, the lower and the upper position will be stored automatically.
The initial operation is completed.



NOTE

The lower position is 3 mm (0.12") higher than the block position. The upper position depends on the lifting element type, resp. of the control box software.

4.1 Plug detection

The control box can detect whether a lifting element is plugged into the relevant socket. In addition, the control box detects whether a lifting element has been replaced.

If a lifting element is missing or if it is replaced, the control box will click 3 times.

After plugging out a lifting element the system must be reset to synchronize all connected lifting elements.

4.2 Duty cycle monitoring

The duty cycle monitoring checks the ratio between the operation time and standstill time. To avoid overheating of the system a duty cycle of 2/18 (ON/OFF) should be maintained.



The maximum continuous operating time is 2 minutes. Afterwards a pause of at least 18 minutes needs to be observed before the system can be operated again.

5 Operation with Hand switch Type Memory



5.1 Drive Up / Down

This function is used for easy height adjustment of the system.

Keep the button  or  pressed until the desired working height is reached.

5.2 Saving and approaching a memory position

With this function it is possible to memorise a certain position/height and approach it at a later time by pushing one button. With the 4 memory buttons up to 4 different positions can be stored and approached.

1. Drive to the desired position and press the button  (Save).

Display:



2. Press one of the buttons    .

After pressing a memory button the display shows «S» and the number of the pressed button.

Example:







After saving there is a double click sound, and after approx. 2 seconds the current height is displayed again.

Example:



To approach a stored memory position:

Keep one of the buttons     pressed until the desired working height is reached.

5.3 Limit the stroke length (Container-Stop/Shelf-Stop)

These two features can be used to limit the stroke length of the lifting system (e.g. if a container is under the table).



NOTE



The Container-Stop position can only be set in the lower half of the stroke length and limits the lower end position.

The Shelf-Stop position can only be set in the upper half of the stroke length and limits the upper end position.

For a Container-Stop position and Shelf-Stop position, the following steps must be performed separately.



5.3.1 Set stroke length limitation

To define a Container-Stop/Shelf-Stop position, proceed as follows:

1. Drive to the desired end position in the lower half (for Container-Stop) resp. in the upper half (for Shelf-Stop) of the movement area.
2. Keep the buttons  and  pressed simultaneously for 10 seconds.
Control box will **click twice** when the new Container-Stop/Shelf-Stop position is stored.

5.3.2 Remove stroke length limitation

To deactivate a Container-Stop/shelf-Stop position, proceed as follows:

1. Drive to the stored end position (Container-Stop/Shelf-Stop position).
2. Keep the buttons  and  pressed simultaneously for 10 seconds.
Control box will **click once** when the existing Container-Stop/Shelf-Stop position is deactivated.

5.4 Setting the shown height on the display

The displayed height can be adjusted with this feature.

1. Drive to any desired height and press the button  (Save).



Display:

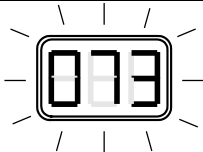

2. Keep the button  pressed for about 5 seconds, until the display starts flashing.

Example:



3. Now the button  (plus) or  (minus) can be used to set the current height.
While doing so, the system does not move!
4. With the correctly set value the new height is saved by pressing  (Save).





5.5 Changing the displayed unit of measurement (cm/inch) – Reset «S 5»

This function can be used to change the height unit on the display from «cm» to «inch» or from «inch» to «cm».



NOTE

No lifting movement is allowed during the reset.

1. Press the buttons ,  and  simultaneously, until «S 5» or «S 7» is displayed.
The control box is now in setting mode.
2. Press the button  until «S 5» is displayed.
3. Press the button  (Save).
Control box clicks 2 times ...

The unit of measurement on the display has now been changed from centimeters (cm) to inches (inch) or from inches to centimeters (2.54 cm = 1 inch).

5.6 Restore to factory settings – Factory reset «S 0»

ATTENTION



Before restoring to factory settings, it must be ensured that:

- the lifting element can retract completely.
- the lifting system is loaded with a maximum of 50% of the maximum allowed system load.







If the lifting element cannot retract completely and hits a stop before it reached its lower block position, the zero position is set incorrectly. This leads to a collision when moving up to the upper block position.



NOTE

During restoring to the factory settings, the lifting system drives with half the speed.

When restoring the factory settings, the entire system is newly set up again.
All settings such as Memory positions or End positions are lost.

1. If possible: Drive to lowest position 
→ This saves time because the system only drives with half speed when doing a reset.
2. Press the buttons ,  and  simultaneously, until «S 5» or «S 7» is displayed.
The control box is now in setting mode.
3. Press the button  until «S 0» is displayed.
4. Press the button  (Save).
Control box clicks 3 times and the display shows «E70»!
5. Disconnect power cable and wait for at least 5 seconds.
Connect the power cable. *The display is flashing «000»!*
6. Perform the initial operation according to chapter 4.

5.7 Reference drive – Referencing the end positions – «Long Key Down»

ATTENTION



Before the reset, it must be ensured that:

- the lifting element can retract completely.
- the lifting system is loaded with a maximum of 50% of the maximum allowed system load.

If the lifting element cannot retract completely and hits a stop before it reached its lower block position, the zero position is set incorrectly. This leads to a collision when moving up to the upper block position.



NOTE

During restoring to the factory settings, the lifting system drives with half the speed.

1. Drive the system to the programmed lowest position.
2. Keep the button  pressed for 5 seconds («Long Key Down»)
The system moves downwards to the lower block position and resets itself like during the initial operation.

6 Operation with Hand switch Type Up-Down



6.1 Drive Up / Down

This function is used for easy height adjustment of the system.

Press the button  or .

Keep the button pressed until the desired working height is reached.

7 Synchronous operation of 2, 3 or 4 control boxes

7.1 Cable connections

Up to three lifting elements can be connected to one control box Compact-3-eco.
By cascading (synchronizing) multiple control boxes they can be controlled simultaneously with just one hand switch. The control boxes can be connected using the SYNC-2 cable (124.00088) or the SYNC-4 cable (124.00089).

SYNC-2 Cable



With the SYNC-2 cable 2 control boxes Compact can be connected and synchronised.
The length of the SYNC-2 cable is 550 mm (21.7").

The SYNC cable cannot be extended. If necessary, the motor cables can be extended!



NOTE

Always do reset before disconnecting!
Disconnect plug carefully → Risk of rip-out!

SYNC-4 Cable



With the SYNC-4 cable 2, 3 or 4 control boxes Compact can be connected and synchronised.
The length of SYNC-4 cable is 1'800 mm (71").
Two connected SYNC-4 cables have a length of 2.0 m (78.7").

Each control box needs one SYNC-4 cable.

The SYNC cable cannot be extended. If necessary, the motor cables can be extended!

The SYNC-4 cables of each control box are to be connected to each other.

→ The loose ends do not have to be connected. However, connecting the loose ends will not have any influence on the system.

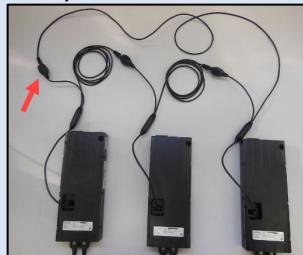

7.2 Commissioning the synchronized systems

1. Connect the motor cables to the lifting columns.
2. Connect the motor cables to the control box in the correct order from **M1** to **M3**.
(Automatic plug detection on all sockets)
3. Connect the control boxes using the SYNC-2 cable for two control boxes, or the SYNC-4 cable for 2, 3 or 4 control boxes.
4. Connect hand switch to desired control box.
Only one hand switch is necessary. The control box with the hand switch is the master control box. All other control boxes are subordinated.
5. Connect the power cable to the control box.

**NOTE**

Before connecting the power cable to the mains the following must be verified:

- Does the mains voltage correspond to the value on the name plate of the control box?
- Are the plugs of the motor cable connected to the correct sockets (**M1, M2, M3**)?
- Is the entire lifting system assembled according to the assembly instructions?

6. Connect power cable to the mains. (Click sound → ready for initial operation)
7. Perform the initial operation according to chapter 4.

ATTENTION



The SYNC cable must be connected to the control box before the control box is connected to the mains.
If the SYNC cables are connected afterwards, they will not be recognised by the control box and only one control box works, which can lead to jamming of the entire system!

**NOTE**

When disconnecting the SYNC cable uncarefully, the plug can be ripped out of the print platine!

7.3 Operation scenarios – FAQ

Scenario: Connecting the hand switch to another control box

- Display blinks «- - -».
- Hand switch doesn't work.
- Hand switch ONLY works on the the master control box.

Scenario: Disconnecting or reconnecting the synchronisation cable

- Display blinks «000».
- Then display blinks «E93».
- Perform a Factory reset «S 0» according to chapter 5.6
(all controls are reset to factory settings).

Scenario: Power cut

- All saved positions are stored.
- Synchronisation is stored.
- Getting back the power, no initial operation necessary.
The system can be used as usual.

Scenario: Power cut on only one control box

- Display blinks «000».
- Then display blinks «E93».
- Perform a Factory reset «S 0» according to chapter 5.6
(all controls are reset to factory settings).

8 Safety strip – Squeezing protection

ATTENTION



With lifting systems of Ergoswiss AG it is important to make sure that no objects or people are trapped during the lifting movement.
Danger of squeezing during lifting movement!

Attach the safety strip to an assumed squeeze zone. If the safety strip gets squeezed while the system moves, the motor will stop instantly and turn back for 5 motor rotations (20 mm (0.79")).

The Safety strip Compact cpl. (124.00105) consists of:

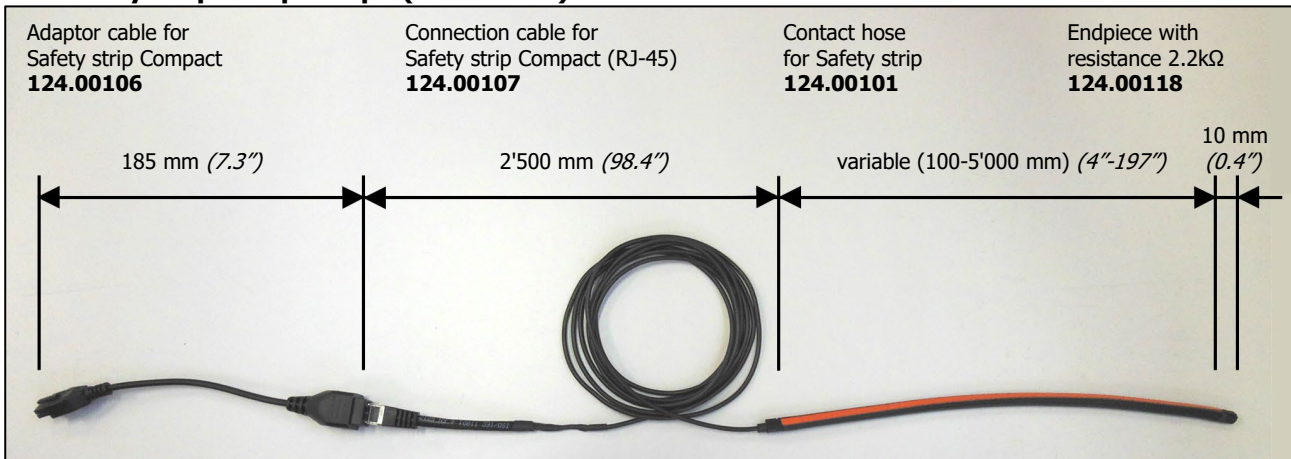

Functional properties of the contact tube

Contact angle	< 80 °
Switching pressure	< 25 N bei 23 °C
Switching travel	< 2 mm bei 23 °C
Minimum bending radius	B1 120 mm / B2 150 mm B3 20 mm / B4 20 mm
Max. tensile load	20 N

Electrical properties

Terminal resistance	2.2 kΩhm
Max. switching capacity	250 mW
Max. voltage	DC 24 V
Current min. / max.	1 mA / 10 mA

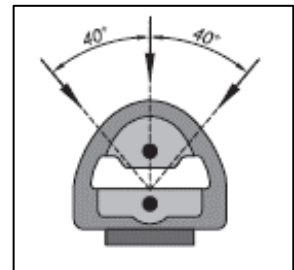
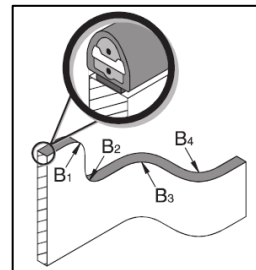

8.1 Commissioning

Gluing the contact tube in the squeeze zone

1. Clean and degrease the contact face
2. Remove 10-15 cm (4'' to 6'') of protective film from the adhesive surface
3. Place it on the contact face and press on well
4. Repeat steps 2 and 3 until the contact tube is completely glued on
5. Maximum adhesion is reached after 24 h

Initial operation of control box with the safety strip

1. Wire the control box according to chapter 3.2. The safety strip is connected in step 2.b
2. Perform an initial operation according to chapter 4.

Adding the safety strip to existing control box

1. Reset the controller to factory setting (Factory reset «S 0») according to chapter 5.5.
2. The safety strip is connected in step 2.b.

9 Maintenance and disposal

9.1 Maintenance and cleaning

The lifting system is maintenance-free during normal operation resp. when complying with the intended use. Therefore a service is not required.

ATTENTION



The control box and the hand switch must only be cleaned with a dry or damp cloth. Before cleaning, the power cable has to be separated from the mains!

ATTENTION



No liquid is allowed to enter the plug connections!

9.2 Repairs and spare parts

Repairs must only be conducted by specialists. Only original replacement parts may be used. For all repair work the system must always be unloaded and voltage-free.

ATTENTION



In no case may the control box be opened! There is the risk of an electrical shock!

9.3 Disassembly and disposal

When decommissioning and disposing of the lifting system the electronic parts must be disposed of separately. The system consists of components that can be fully recycled and thus they are quite safe from an environmental protection perspective. The electronic parts comply with the RoHs directive.



9.4 Electrical and Electronic Equipment Act

The lifting system is not covered by the Electrical and Electronic Equipment Act (WEEE Directive 2012/19/EU).

Lifting systems from Ergoswiss AG are intended for installation in an overall system (e.g. assembly table) and classified under the category of incomplete machines in accordance with the Machinery Regulation (EU) 2023/1230.

Therefore, these systems are not intended for private use.

10 Error codes on the display

Display	Cause	Trouble shooting
	The control box compact is equipped with an overheating protection. This overheating protection will activate due to too high temperatures	Wait until the control box has cooled down and the message «HOT» is no longer displayed. Then the control box is ready for operation again.
	There is an internal error at the control box.	Proceed according to the following error list.
blinking 000	Motor position lost	Perform a «Long Key Down».
00	Internal error channel 1	Disconnect the power cable from the mains and contact the customer support.
01	Internal error channel 2	
02	Internal error channel 3	
12	Defective channel 1	Insert the motor cable correctly.
13	Defective channel 2	
14	Defective channel 3	
24	Excess current motor M1	System overloaded → Remove load from the system
25	Excess current motor M2	
26	Excess current motor M3	
48	Excess current motor group 1	System jammed → Remove clamped object
49	Excess current motor group 2	
60	Collision protection	
62	Excess current at the control	Plug in the motor cable correctly at the respective socket. Perform a Factory reset «S 0».
36	Plug detection at motor socket M1	
37	Plug detection at motor socket M2	
38	Plug detection at motor socket M3	
61	Motor replaced	
55	Synchronising of the motor group 1 impossible	Remove load from the system. Perform a Factory reset «S 0».
56	Synchronising of the motor group 2 impossible	Contact the customer support if the error remains displayed.
67	Too high voltage	Disconnect the power cable from the mains. Contact the customer support.
70	Change of the drive configuration	Disconnect the power cable from the mains and wait at least for 5 seconds. Reconnect the power cable. Perform a Factory reset «S 0».
81	Internal error	Disconnect the power cable from the mains and wait at least for 5 seconds. Reconnect the power cable. Perform a Factory reset «S 0». Contact the customer support if the error remains displayed.
93	Connection error while synchronising The error is displayed for 15 seconds, then the control box changes to the reset mode with a flashing display of «000».	Disconnect the power cable from the mains and wait at least for 5 seconds. Reconnect the power cable. Perform a Factory reset «S 0».

10.1 Click codes

As soon as the lifting system is supplied with current the control utilises the integrated relays to acoustically indicate the system state as well as the reason of the last shut down to the user.

Number of clicks	Status information
2x	Normal operation: The system works flawlessly.
1x	Emergency operation: The system is in emergency mode; the motors cannot be operated. There is an error code to be checked on the display.
3x – 6x	Last shut down incomplete / forced reset: There is an error code to be checked on the display.

10.2 Trouble-shooting

ATTENTION



The lifting system must not be opened, reworked or operated by impermissible components.

Error	Cause	Rectification
Drive does not work	Control box not connected	Connect power cable
	Motor not connected	Connect motor cable
	Motor defective	Contact the customer support
	Control box defective	Contact the customer support
	Hand switch defective	Replace the hand switch
	Bad connector contact	Plug in all plugs correctly
Drive only move to one direction	Control box defective	Contact the customer support
	Hand switch defective	Replace the hand switch
Drive only moves downwards	System overload	Remove weight from the system

11 Declaration of Incorporation

EG-Declaration of Incorporation in the sense of the Machinery Directive 2006/42/EG annex II 1B

We hereby declare that for the incomplete machine „spindle lifting system“, for ergonomically height adjustable workplaces or similar, with the variants

Lifting system SL xxxx Compact	(Art. Nr. 901.2xxxx)
Frame SL xxxx Compact	(Art. Nr. 901.3xxxx)
Lifting system SM xxxx Compact	(Art. Nr. 902.2xxxx)
Frame SM xxxx Compact	(Art. Nr. 902.3xxxx)
Lifting system SK xxxx Compact	(Art. Nr. 910.2xxxx)
Frame SK xxxx Compact	(Art. Nr. 910.3xxxx)

the following essential requirements of the Machinery Directive 2006/42/EG are applied and complied with:

1.1.2.; 1.1.3.; 1.1.5.; 1.1.6.; 1.2.; 1.3.2.; 1.3.9.; 1.5.1.; 1.5.3.; 1.5.7.; 1.5.8.

In particular the applied harmonized standards:

EN 1005	Safety of machinery: Physical performance
EN ISO 12100	Safety of machinery: 2011
EN 55014	Electromagnetic compatibility
EN 60335	Safety of electrical appliances for household use
EN 60204	Electrical equipment of devices
EN 61000	Electromagnetic compatibility: EMC
EN 62233	Houshold electrical appliances EMC, evaluation and measurement

specific technical documentation have been created in accordance with annex VII, part B, and will be sent to the national authorities by registered letter or electronically, if the request is justified, and this incomplete machine is in conformity with the relevant provisions of other EU Directives:

89/391/EG	Safety and health of workers
2001/95/EG	General product safety
2014/30/EU	Directive on electromagnetic compatibility
2014/35/EU	Low voltage directive

Furthermore, we declare that this incomplete machine may only be commissioned if it has been determined that the machine in which the incomplete machine is to be installed complies with the provisions of the Machinery Directive 2006/42/EG and our assembly and service operating instructions have been followed.



Widnau, 13. September 2023
Martin Keller
Managing Director / CEO

Document responsibility EU:

Ergoswiss Deutschland GmbH
Kronenstrasse 1
DE-72555 Metzingen