

beigelegt / enclosed:

- Steuerung compact-eco / control box compact-eco
- länderspezifisches Netzkabel / country specific power cable
- Kabelfernbedienung D/Memory / cable remote control D/Memory

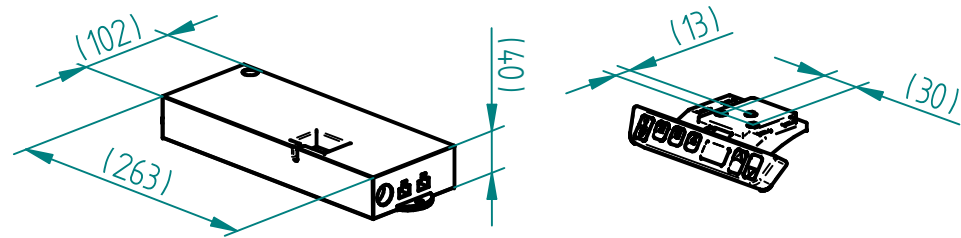

Pumpe mit Antrieb
Pump with motor unit

Pumpe mit umklappbarer Handkurbel
Pump with foldable hand crank

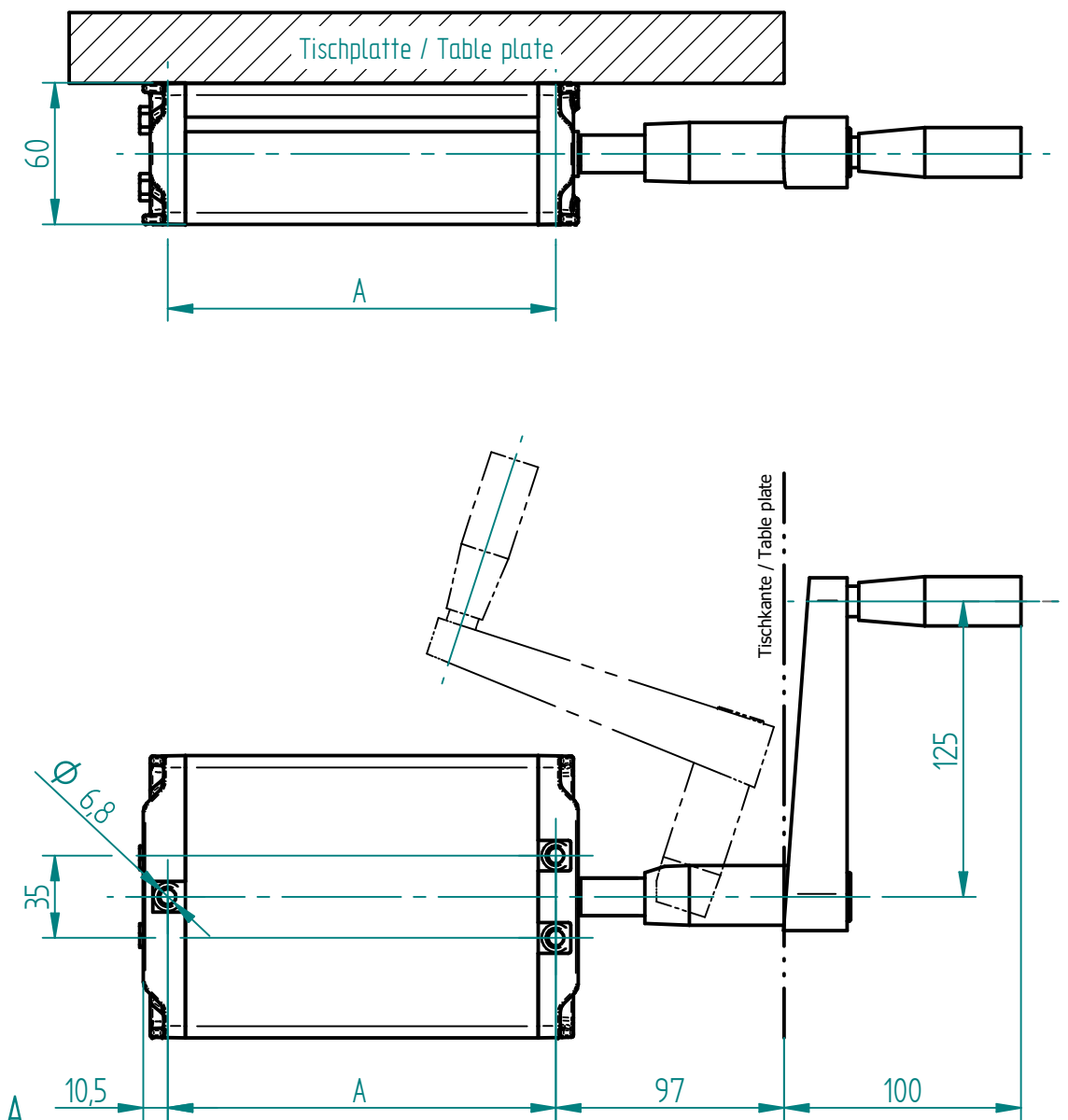
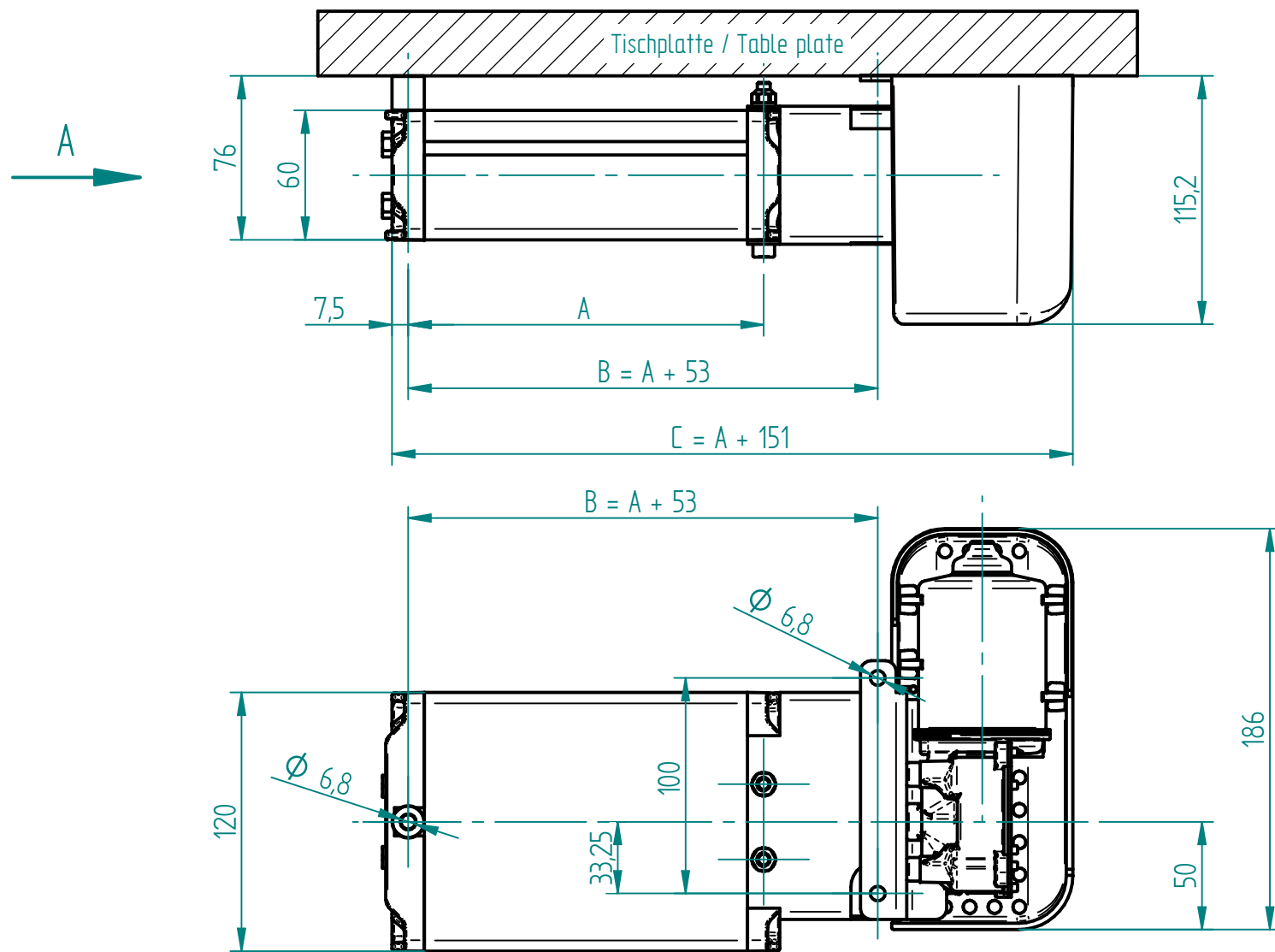

Ansicht A / View A

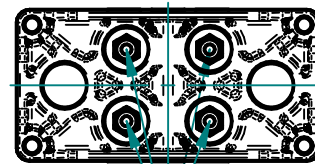

Schlauchanschluss
Tubing connection

Pumpe / Pump	A	B	C	mit Antrieb EU with Motor unit EU	mit Antrieb CH with Motor unit CH	mit Antrieb US with Motor unit US	mit Handkurbel with Hand crank
PB 4418 W	465.5	518.5	616.5	322.20153	332.20153	362.20153	312.20153
PB 4430 W	707.5	760.5	858.5	322.20155	332.20155	362.20155	312.20155
PB 4440 W	908.5	961.5	1059.5	322.20157	332.20157	362.20157	312.20158

Index	Datum / Date	Name	Änderungsmittellung / notification of change		
	DATUM / DATE	NAME	GEWICHT / WEIGHT	BEZEICHNUNG / ASSEMBLY NAME	
GEZEICHNET / DRAWN	30.04.2016	tiho	---	Pumpe PB 44XX W mit Antrieb/Handkurbel	
GEPRÜFT / CHECKED	30.04.2016	anhe	MABSTAB / SCALE	Pump PB 44XX W with motor unit/hand crank	
ERGO SWISS Dynamic Systems			ZEICHNUNGSNUMMER / DRAWING NUMBER	ARTIKELNUMMER / ASSEMBLY NUMBER	INDEX
			a-3X2.009	3X2.XXXXX	00
					A3