

## Operation instruction – Spindle lifting system SE with SCT iSMPS

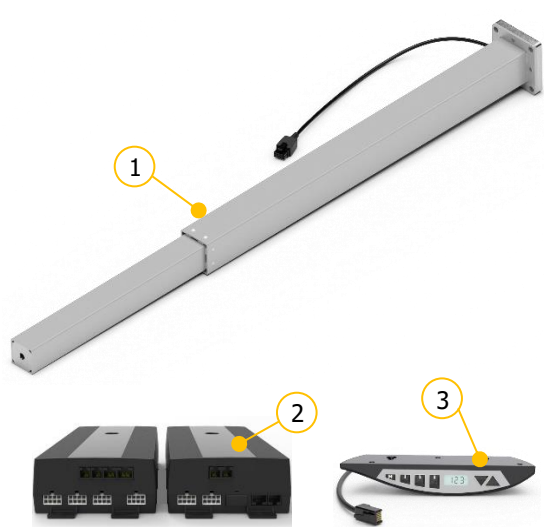

It is essential to read this operating instruction thoroughly before commissioning the system.



- ① Spindle column type SE
- ② control box SCT iSMPS
- ③ Manual control switch Memory

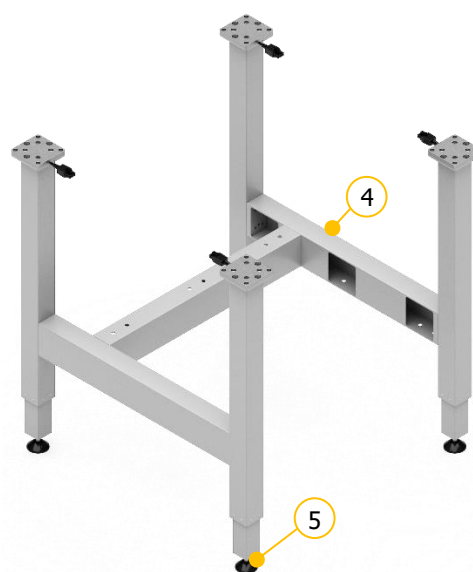

- Example of a table frame with four lifting columns
- ④ Cross bar
  - ⑤ Table feet

Errors and technical changes reserved.

Ergoswiss AG does not assume any liability for operating errors or using the products outside of the intended purpose use.

At the time of delivery Ergoswiss AG will replace or repair defect products within accordance with the warranty provisions. In addition, Ergoswiss assumes no other liability.

For your questions and special custom demand Ergoswiss AG will be at your disposal.

**Ergoswiss AG**

Nöllenstrasse 15

CH-9443 Widnau

Tel.: +41 (0) 71 727 06 70

Fax: +41 (0) 71 727 06 79

info@ergoswiss.com

www.ergoswiss.com

## This operating instruction applies to:

### Lifting system SE with control box SCT iSMPS

Example.: Lifting system SE 4330 EU 12 (Item number: 908.41036)

	Description	Standard version
SE	Lifting column type	SE
4330	Number of lifting columns	1, 2, 3, 4
4330	Spindle pitch in mm	3 mm
4330	Stroke length in cm	30 cm
EU	Power cable	EU, CH, US
12	12 = manual control switch Memory	12

### Frame SE with control box SCT iSMPS

Example.: Frame SE-4 1330 1200 EU 12 (Item number: 908.51074)

	Description	Standard version
SE	Lifting column type	SE
-4	Number of lifting columns	1, 2, 3, 4
1330	Spindle pitch in mm	3 mm
1330	Stroke length in cm	30 cm, 40 cm
1200	Distance between lifting columns	Telescopic cross bar
EU	Power cable	EU, CH, US
12	12 = manual control switch Memory	12

### Other versions

	Description
M12	With M12 thread connection
2P	With 2 welding plates for attaching a cross bar
s01-s99	Special version: different position of threads, color, etc.

## Notes on the operating instructions:

Lifting systems of Ergoswiss AG are intended for installation in a complete system and are classified in the category of incomplete machines in accordance with the Machinery Directive 2006/42/EC. This manual contains information on the commissioning, handling and safety of the lifting system and is intended for the re-user and manufacturer of the entire system. The re-user of this lifting system is obliged to draw up an operating manual with all usage information and hazard warnings of the entire system.

The installation declaration is only valid for the Ergoswiss lifting system and not for the overall system created by the re-user.

## Table of content

<b>1</b>	<b>Safety requirements</b> .....	<b>4</b>
1.1	Explanations of the symbols and notes .....	4
<b>2</b>	<b>System description</b> .....	<b>5</b>
2.1	General .....	5
2.1	Intended purpose use .....	6
<b>2.2</b>	<b>Target group and prior knowledge</b> .....	<b>6</b>
2.3	Performance characteristics .....	7
2.3.1	Lifting column SE .....	7
2.3.2	Control box SCT2 iSMPS and SCT4 iSMPS .....	8
2.3.3	Manual control switch Memory .....	8
2.3.4	System data .....	9
<b>3</b>	<b>Mounting instructions</b> .....	<b>10</b>
3.1	Mounting instructions spindle column .....	10
3.2	Mounting the control box and connecting the cables .....	12
3.3	Mounting the hand switch (cable remote control).....	13
3.3.1	Cable remote control SCT Memory T6 .....	13
<b>4</b>	<b>Initial operation</b> .....	<b>14</b>
4.1	Duty cycle monitoring (ED).....	14
<b>5</b>	<b>Operation with the hand switch type Memory</b> .....	<b>15</b>
5.1	Up / Down.....	15
5.2	Saving and approaching a memory position .....	15
5.3	Limit the stroke length .....	16
5.3.1	Limit lower end position - Container-Stop .....	16
5.3.2	Limit upper end position - Shelf-Stop.....	16
5.4	Locking the movement (child protection) .....	17
5.5	Changing the measurement unit mm / inch .....	17
5.6	Setting the shown height on the display .....	17
5.7	Restore factory settings.....	18
5.8	Reset / initialize the end positions .....	19
5.9	Deactivating /activating the tilt sensor .....	20
<b>6</b>	<b>Synchronize 2 control boxes</b> .....	<b>21</b>
6.1	Commissioning.....	21
<b>7</b>	<b>Safety strip</b> .....	<b>22</b>
7.1	Commissioning.....	22
<b>8</b>	<b>Maintenance and disposal</b> .....	<b>23</b>
8.1	Maintenance and cleaning .....	23
8.2	Repairs and spare parts.....	23
8.3	Disassembly and disposal .....	23
8.4	Electrical and Electronic Equipment Act .....	23
<b>9</b>	<b>Error codes and trouble shooting</b> .....	<b>24</b>
9.1	Error codes on the display .....	24
9.2	Trouble shooting .....	25
<b>10</b>	<b>Declaration of Incorporation</b> .....	<b>26</b>

## 1 Safety requirements

The safety instructions must be observed! If the system is operated improperly or not according to the intended purpose, dangers for persons and objects can arise!

Before installing and operating the lifting system, this manual must be read and understood. The instructions must be kept in the immediate vicinity of the system for lookup.

### 1.1 Explanations of the symbols and notes

Please pay attention to the following explanations of the symbols and notes. They are classified according to ISO 3864-2.

#### DANGER



Indicates an immediate threatening danger.  
Non-compliance with this information can result in death or serious personal injuries (invalidity).

#### WARNING



Indicates a possible dangerous situation.  
Non-compliance with this information can result in death or serious personal injuries (invalidity).

#### ATTENTION



Indicates a possible dangerous situation.  
Non-compliance with this information can result in damage to property or light to medium personal injuries.



#### NOTE

Indicates general notes, useful operator advice and operating recommendations which do not affect safety and health of the user.

## 2 System description

---

### 2.1 General

---

The basic functionality of a spindle lifting system SE by Ergoswiss AG is the lifting and lowering of work surfaces, machine parts, profile systems, etc.

An operative spindle lifting System SE consists of a minimum of following components:

- Lifting column
- Control box
- Manual control switch Memory
- Power cable

The lifting column SE consists of a powder coated steel guiding with cross section 50x50 mm. The inner tube is guided with plastic gliders and is moved by an inline spindle drive. Up to 4 spindle lifting columns can be connected to one control box SCT4 iSMPS and be operated synchronously.

The high-performance control box SCT4 iSMPS is equipped with two or four motor channels, which are adjusted synchronously by an encoder converter. Due to the optimised driving comfort, the end positions are gently approached as low-speed zones up to the standstill. An integrated tilt sensor reacts to the system tipping and can prevent potentially dangerous situations. Additional functions, such as the synchronisation of two control boxes or the connection of safety strips (squeezing protection) can be used.

With the separately available manual control switch Memory the spindle system can be operated comfortably, the work surface will be adjusted steplessly in its height. The current height of the work surface is continuously shown on the display (cm or inches). Up to three different memory positions can be stored and approached individually. Errors that occur are also shown on the display.

## 2.1 Intended purpose use

Field of application	NO field of application
<ul style="list-style-type: none"> <li>• Height adjustment of work surfaces</li> <li>• Height adjustment of machine parts</li> <li>• Height adjustment of profile systems</li> <li>• ... List not final</li> </ul>	<ul style="list-style-type: none"> <li>• Clamping device</li> <li>• Press (or counter stop for press)</li> <li>• Passenger transport</li> <li>• Security component</li> <li>• ... List not final</li> </ul>

### The lifting system can be used if:

- it is located at enclosed spaces, dry and non-explosive environments.
- ambient temperature is between +10 °C and +40 °C.
- relative humidity range is between 30 % and 70 % (not condensed).
- there are no strong electromagnetic fields nearby.

### The lifting system must not be:

- operated outside the performance data (tensile, pressure, bending torque)
- loaded with pulse or impact forces (e.g. displacing loads).
- designed for continuous operation (the duty cycle (On/Off) must not exceed 2/18).
- operated with inadmissible or unintended components (e.g. different types of lifting column; Replacement of the controller (control software))
- operated with damaged components
- open or post-processed
- used by children under 8 years of age or persons with limited physical, sensory or mental abilities. Unless they are supervised by a person responsible for their security or receive instructions by this very person on how to use the device.

When installing and operating the lifting system, the intended purpose of the entire system must be adhered to. Commissioning is prohibited until the entire plant complies with the provisions of EG Machinery Directives 2006/42/EG (Machinery Directive). For this purpose, it is essential to perform a risk analysis, so that possible residual hazards can be reacted to (e.g. by constructive measures or by means of instructions in the operating instructions or/and by safety instructions on the system). In the event of improper use, the liability of Ergoswiss AG as well as the general operating license of the lifting system expires.

## 2.2 Target group and prior knowledge

Before installing and operating the lifting system, this operation instruction must be read and understood. The user manual must be kept in the immediate vicinity of the system for a look-up. This manual is intended for the following groups of people:

The **manufacturer of the complete system**, who integrates this lifting system into a complete system and integrates this operating manual into the operating instructions of the entire system.

The **commissioning personnel**, who install the lifting system in a workstation, a machine, etc. and put it into operation. Basic mechanical and electrotechnical knowledge is required during commissioning.

## 2.3 Performance characteristics

### 2.3.1 Lifting column SE

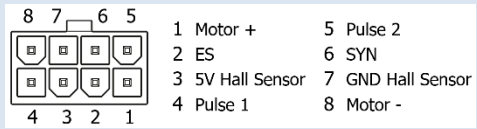
<b>Cross-section</b>	50 x 50 mm (2" x 2")
<b>Standard stroke length</b>	300 mm (12")
<b>Installation length</b>	640 mm (25.2")
<b>Weight</b>	SE 1330 = 4.6 kg (10.2 lbs)
<b>Max. allowed pressure load</b>	1250N
<b>Max. allowed tensile load</b>	1250N
<b>Voltage</b>	24 V
<b>Lifting speed</b>	9 mm/s (0.12 in/s)
<b>Noise level</b>	< 60 dBA
<b>Protection class (DIN EN 60529)</b>	IP 20
<b>Electrical connection</b>	<p>Molex MiniFit plug 8 Pin Cable length 2000 mm (78.7")</p> 
<b>End switch</b>	No (reading Encoder)
<b>Tested product life</b>	5000 cycles with 300 mm (11.8") stroke length, 1250 N (281 lbf) pressure load, ED 2/18 ①

① Duty Cycle 2/18; operating max. 2 min, pause 18 min

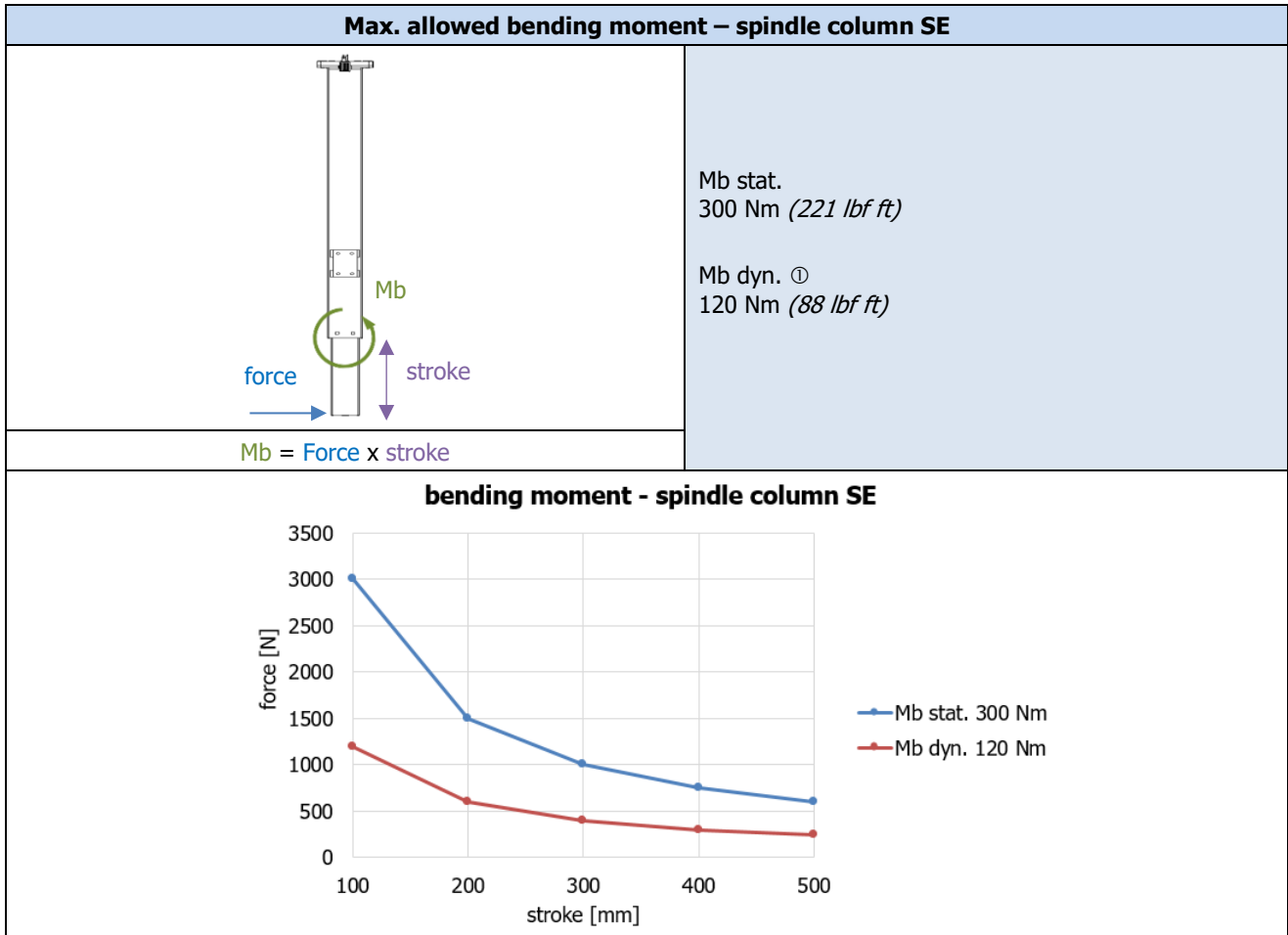

① dyn. = during the lifting movement

### 2.3.2 Control box SCT2 iSMPS and SCT4 iSMPS

<b>Dimension (L, B, H)</b>	309 x 120 x 55 mm (12.2" x 4.7" x 2.2")	
<b>Weight</b>	1.1 kg (2.4 lbs)	
<b>Supply voltage</b>	EU: 207-254.4 V / 50 Hz / 4.5 A	US: 103.5–127.2 V / 60 Hz / 7.4 A
<b>Primary standby power</b>	< 0.6 W	
<b>Power</b>	580 VA	
<b>Protection class (DIN EN 60529)</b>	IP 20	
<b>Performance Level (DIN EN 13849-1)</b>	PL b	

### 2.3.3 Manual control switch Memory

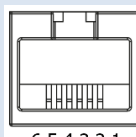
<b>Electrical connection</b>	RJ-12 plug 6 Pin Cable length 2000 mm (78.7")	 <p>1 UP    4 5V 2 RX    5 DOWN 3 GND    6 TX 6 5 4 3 2 1</p>
	<b>Protection class (DIN EN 60529)</b>	



### 2.3.4 System data

# spindle column	Max. system load		Stroke length		Linear unit Type	Control box type		Lifting speed	① Duty Cycle [On/Off]
	[kg]	[lbs]	[mm]	[in]		230 V	110 V		
1	125	275	300	12	SE 1330	SCT2 iSMPS	SCT4 iSMPS	9 mm/s (0.35"/s)	2/18
2	250	550	300	12	SE 1330	SCT2 iSMPS	SCT4 iSMPS		
3	375	825	300	12	SE 1330	SCT4 iSMPS			
4	500	1100	300	12	SE 1330	SCT4 iSMPS			
5	625	1375	300	12	SE 1330	2x SCT4 iSMPS			
6	700	1540	300	12	SE 1330	2x SCT4 iSMPS			
7	750	1650	300	12	SE 1330	2x SCT4 iSMPS			
8	800	1760	300	12	SE 1330	2x SCT4 iSMPS			

①: Duty Cycle ED 2/18; operating max. 2 min, pause 18 min

#### NOTE



The lifting system can be subjected to uneven loads as long:

- the max. load on the lifting column (1250 N, 281 lbf) is not exceeded,
- the max. bending torque of the lifting columns is not exceeded,
- the entire system is located on sufficient safe ground
- and the entire plant has been constructed in accordance with the provisions of the mechanical equilibrium. -> Conducting a risk analysis

#### ATTENTION



High pulse / impact forces due to the discontinuation of loads are not allowed.  
(e.g. discontinuation of loads in feed with crane or forklift)

### 3 Mounting instructions

#### 3.1 Mounting instructions spindle column



**NOTE**

The lifting system must be mounted in such a way, that driving to the lowest position is possible at any time.

Otherwise, no initial operating and reset of the system can be carried out.

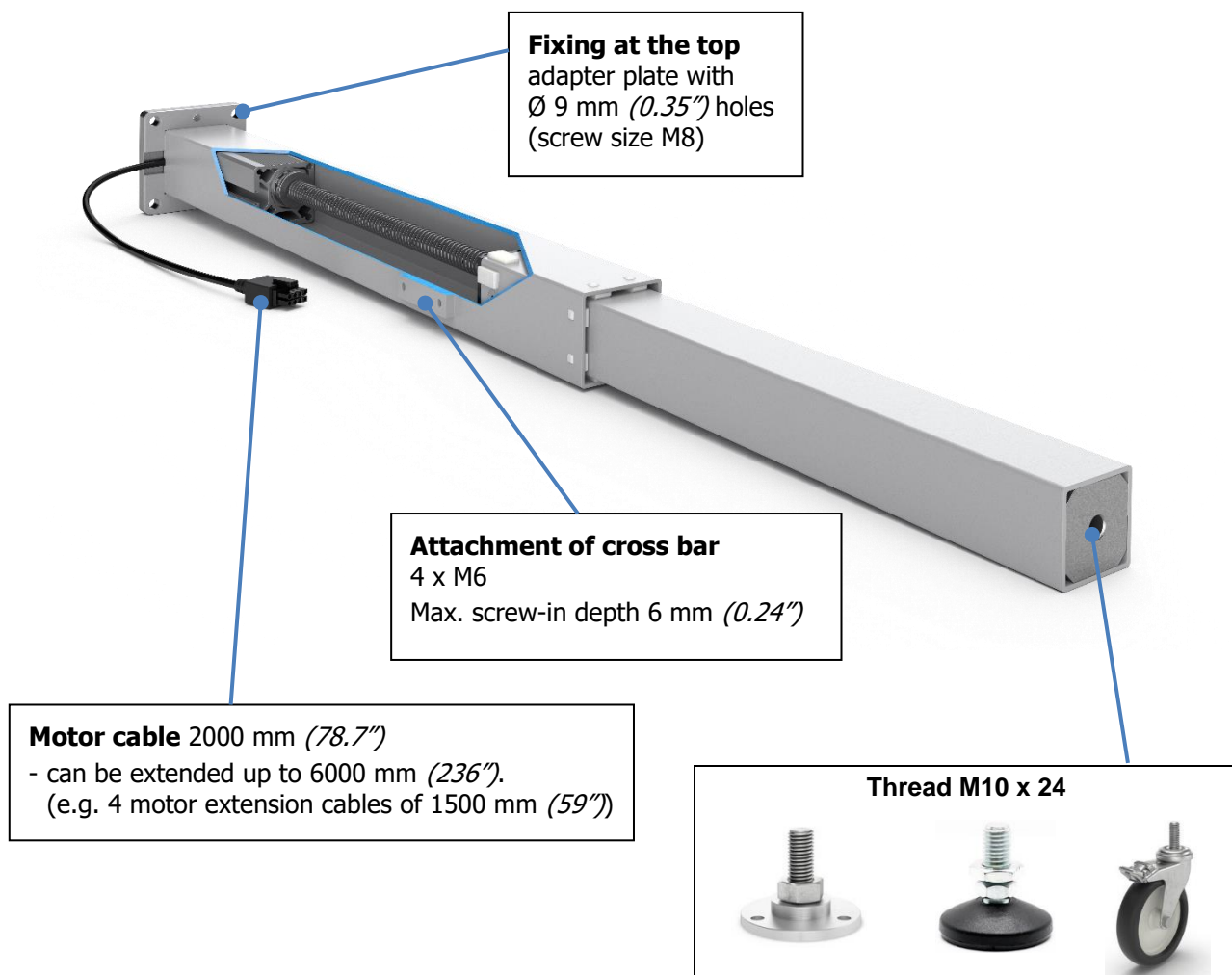

**Motor cable** 2000 mm (78.7")  
- can be extended up to 6000 mm (236").  
(e.g. 4 motor extension cables of 1500 mm (59"))

**Attachment of cross bar**  
4 x M6  
Max. screw-in depth 6 mm (0.24")

**Fixing at the top**  
adapter plate with  
Ø 9 mm (0.35") holes  
(screw size M8)



**Spindle column type SE**

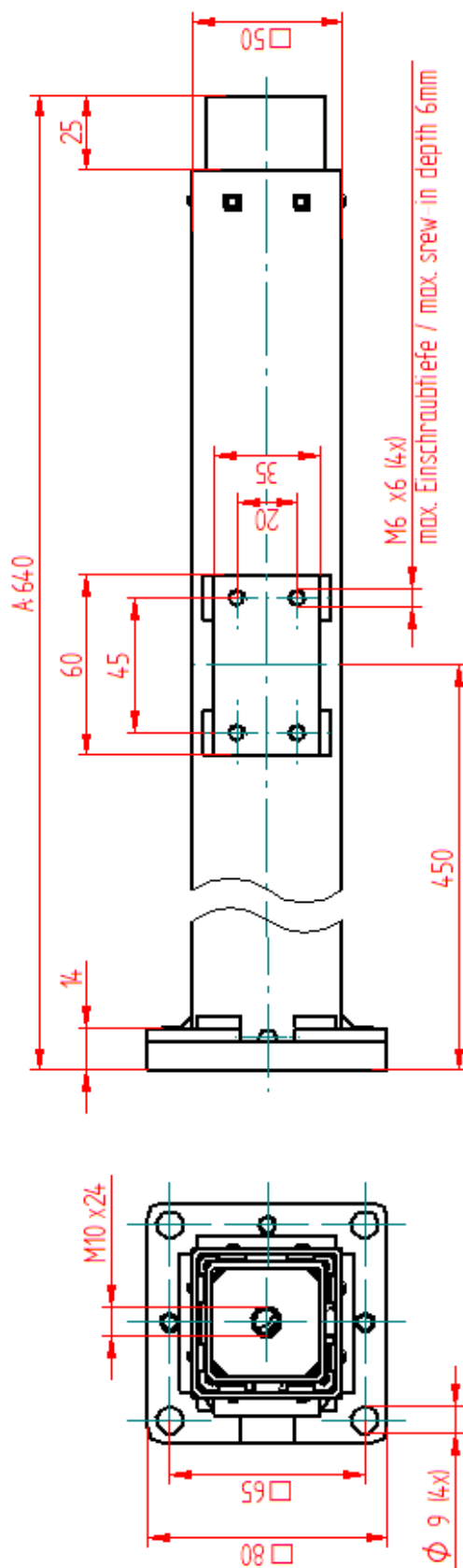

(drawing in mm)

### 3.2 Mounting the control box and connecting the cables

#### ATTENTION



During mounting of the control box the power cable needs to be disconnected from the mains!



#### NOTE

The control box has got an integrated tilting sensor as standard. To ensure smooth normal operation, the controller must be fixed rigidly to the system before initial commissioning. (e.g. below the tabletop)

Mounting the control box at the bottom of a tabletop:

1. Place the control box to the desired location and mark the drill holes with a pen
2. Pre-drill three holes (Ø 2.5 mm / 0.1"). Be careful not to drill through the tabletop!
3. Fix the control box with three screws torque max. 2 Nm (1.5 lbf ft)

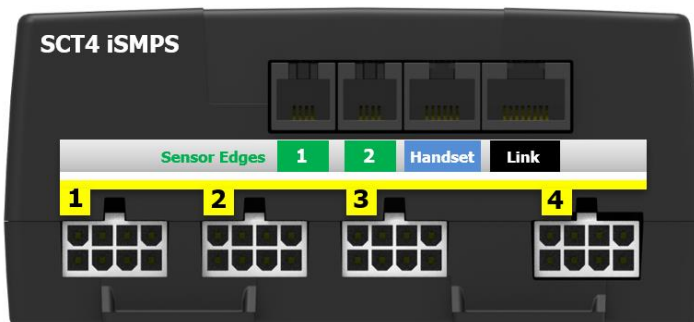
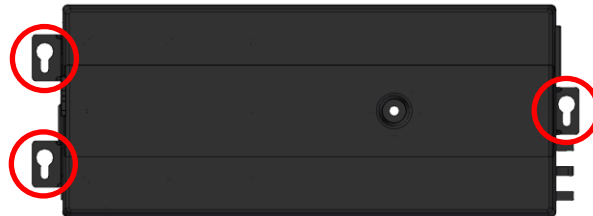

- 1** Connection for safety strip
- 2** Connection for safety strip
- Handset** Connection for manual control
- Link** Connection for sync cable

- 1** Motor socket 1
- 2** Motor socket 2
- 3** Motor socket 3
- 4** Motor socket 4

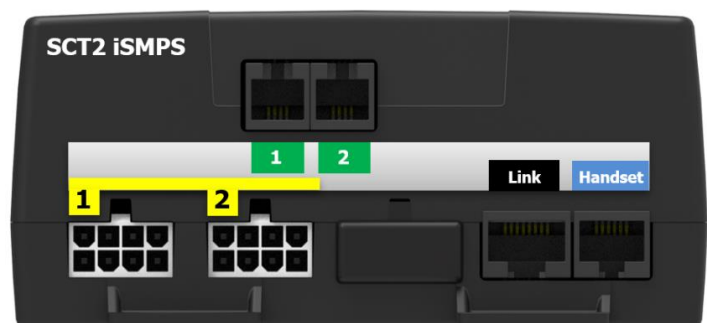

4. Connect the motor cables to the control box in the order from **1** to **4**. (Automatic plug detection on all sockets)
5. Connect the hand switch to the control box ( **Handset** )
6. Connect the power cable to the control box
7. Connect the power cable to the mains

### 3.3 Mounting the hand switch (cable remote control)



**NOTE**

The cable of the cable remote control type Memory can be extended up to 3000 mm (118")  
-> (3x extension cable 124.00290)

#### 3.3.1 Cable remote control SCT Memory T6

1. Position the hand switch at the desired location underneath the tabletop. The control panel must overhang below the work surface!
2. Fix the hand switch by using the mounting screws. Be careful not to drill through the tabletop!

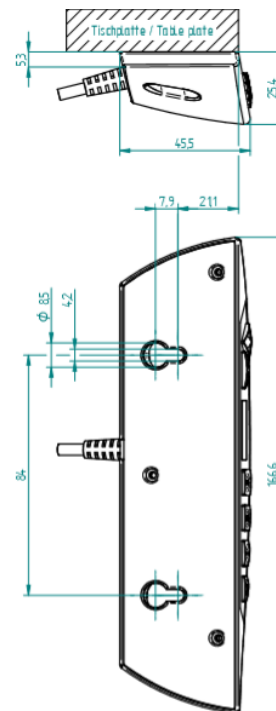

## 4 Initial operation

### ATTENTION



Danger of squeezing during height adjustment

### ATTENTION



The lowest block position must always be reachable.

The lifting element is not allowed to hit a stop before it reached its lowest block position. Otherwise the reference will be stored at a wrong height. This would lead to a collision when driving up to the mechanical block.

### ATTENTION







The system can be fully loaded after the initial operation has been completed. During initial operation, the lifting element can be loaded with a maximum of 60 kg (130 lbs).



### NOTE

During the initial operation, the lifting element drives with half the speed.

1. Keep the buttons  and  pressed simultaneously to drive to the under block position.
  - > The system moves downwards at half speed.
  - > Upward movement is disabled.
2. After reaching the block position, let go of the buttons  and .
  - > The control box will give a signal sound and the system will drive out a few millimeters.
  - > After the drive out, control box will give another two signal sounds.

After reaching the block position, the lower and the upper position will be stored automatically. The initial operation is completed.

(The lower position is 4 mm (0.16") higher than the block position. The upper position depends on the lifting element type, resp. of the control box software.)

### 4.1 Duty cycle monitoring (ED)

The duty cycle monitoring checks for the operation/hold ratio. To avoid overheating of the system a duty cycle of 2/18 (ON/OFF) should be maintained.

The maximum continuous operating time is 2 minutes. Afterwards a pause of at least 18 minutes needs to be observed before the system can be operated again.

## 5 Operation with the hand switch type Memory



---



### 5.1 Up / Down

---



This function is used for easy height adjustment of the system.

- Press the button  or .  
Keep the button pressed until the desired working height is reached.

### 5.2 Saving and approaching a memory position

---

With this function it is possible to memorise a certain position/height and approach it later by pushing one button. With the three memory buttons up to three different positions can be stored and approached.

1. Drive to the desired position and press the button **M** 3-times.
2. Press one of the buttons    within 5 s.  
After saving there is a signal sound.  
The memory position is now stored inside the pressed button.

To approach a stored memory position:











Keep one of the buttons    pressed until the desired working height is reached.

## 5.3 Limit the stroke length

These two features can be used to limit the stroke length of the lifting system (e.g. if a container is under the table). The container stop position limits the lower end position, the shelf stop position the upper end position.

### 5.3.1 Limit lower end position - Container-Stop

To define a Container-Stop position, proceed as follows:











1. Keep the buttons   and  pressed simultaneously for 4 s.  
-> The display shows «S01», while the S is blinking
2. Press the button  or  until «S05» is selected.
3. Confirm the selection «S05» with the button **M**.  
-> The display stops blinking
4. Press the button  or  to drive to the desired Container-Stop position.
5. Confirm with the button **M**.  
-> The display shows «S05»
6. Press the button   or  to leave the menu mode.



To delete a set Container-stop position, a new one has to be done with the same procedure.

### 5.3.2 Limit upper end position - Shelf-Stop

To define a Shelf-Stop position, proceed as follows:

1. Keep the buttons   and  pressed simultaneously for 4 s.  
-> The display shows «S01», while the S is blinking
2. Press the button  or  until «S04» is selected.
3. Confirm the selection «S04» with the button **M**.  
-> The display stops blinking
4. Press the button  or  to drive to the desired Shelf-Stop position.
5. Confirm with the button **M**.  
-> The display shows «S04»
6. Press the button   or  to leave the menu mode.





To delete a set Shelf-stop position, a new one has to be done with the same procedure.



## 5.4 Locking the movement (child protection)



By activating the locking function, the lifting systems can no longer move. Neither a movement with the up / down arrows nor a move to a memory position is possible.

### Activate:











- Press the buttons    simultaneously for 5 s.  
A signal tone sounds. The system is locked. The code «E65» appears.  
If any of the buttons on the hand switch is pressed, a signal tone sound and the system will not move.



### Deactivate:

- Press the buttons    simultaneously for 5 s.  
A signal tone sounds. The system is not locked anymore and can be operated normally.











## 5.5 Changing the measurement unit mm / inch

- Keep the buttons   and  pressed simultaneously for 4 s.  
-> The display shows «S01», while the S is blinking
- Press the button  or  until «S07» is selected.
- Confirm the selection «S07» with the button **M**.  
-> The display blinks «cm» or «inch»
- Press the button  or  to select the desired measurement unit.
- Confirm with the button **M**.
- Press the button   or  to leave the menu mode.







## 5.6 Setting the shown height on the display

- Keep the buttons   and  pressed simultaneously for 4 s.  
-> The display shows «S01», while the S is blinking
- Press the button  or  until «S06» is selected.
- Confirm the selection «S06» with the button **M**.  
-> The display shows the current height («cm» is blinking)
- Measure the height of the table
- Press the button  or  to select the measured height
- Confirm with the button **M**
- Press the button   or  to leave the menu mode.



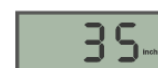



## 5.7 Restore factory settings

### ATTENTION











Before restoring the factory settings, it must be ensured that:

- the lifting element can retract completely.
- each lifting element is loaded with less than 60 kg (130 lbs).



### NOTE

When restoring the factory settings, the entire system is set up again. All settings such as memory or Container-stop positions are lost.

1. If possible: Drive to lowest end position   
-> This saves time because the system only drives with half speed when doing a reset.
2. If needed, the system can now be rewired
  - a. Remove the cable from the mains
  - b. Rewire the system:  
More lifting columns, synchronization cables or safety strips can now be connected.
  - c. Connect the power cable to the mains.
3. Keep the buttons   and  pressed simultaneously for 4 s.  
-> The display shows «S01», while the S is blinking
4. Press the button  or  until «S00» is selected.
5. Confirm the selection «S00» with the button **M**.  
-> A signal tone sounds
6. Press the button   or  to leave the menu mode.  
-> The display shows «EdC»
7. Do an initial operation according to chapter 4.

## 5.8 Reset / initialize the end positions

### ATTENTION



The lowest block position must always be reachable.

The lifting element is not allowed to hit a stop before it reached its lowest block position. Otherwise the reference will be stored at a wrong height. This would lead to a collision when driving up to the mechanical block.

### ATTENTION



The system can be fully loaded after the initial operation has been completed. During initial operation, the lifting element can be loaded with a maximum of 60 kg (*130 lbs*).







#### NOTE

During a reset, the lifting element retracts completely and the end position (reference position) of the lifting element is redefined.



#### NOTE

During the initial operation, the lifting element drives with half the speed.

1. If possible: Drive to lowest end position   
-> This saves time because the system only drives with half speed when doing a reset.
2. Keep the buttons  and  pressed simultaneously to drive to the under block position.  
-> The system moves downwards at half speed. Upward movement is disabled.
3. After reaching the block position, let go of the buttons  and .  
-> The control box will give a signal sound and the system will drive out a few millimeters.  
-> After the drive out, control box will give another two signal sounds.

The reset is now completed.

## 5.9 Deactivating /activating the tilt sensor

The control has an integrated tilt sensor, which is activated by default. The 0° inclination of the control is initialized during initial operation or reset. If the inclination of the control exceeds 2.5° (e.g. inclined table), the controller stops the lifting movement. After triggering the tilt sensor, the system can be released upwards. If this is not possible, a reset according to Chapter 5.8 must be performed.

### ATTENTION



The tilt sensor is not a safety element!  
There is still a risk of injury before the tilt sensor triggers.









### NOTE

In addition to a collision, the inclination sensor can be triggered by different causes. Therefore, the following should be observed:



1. Install control rigidly before initial commissioning or reset  
→ So that the inclination of 0° is properly initialized.
2. After the system is moved, the inclination sensor should be reinitialized  
→ reset according to chapter 5.8
3. For mobile applications (e.g. table on rollers), the inclination sensor should be deactivated.

The tilt sensor is deactivated (or activated), when following commands are executed:

1. Keep the buttons   and  pressed simultaneously for 4 s.  
-> The display shows «S01», while the S is blinking
2. Press the button  or  until «S08» is selected.
3. Confirm the selection «S08» with the button M.  
-> A signal tone sounds
4. Press the button   or  to leave the menu mode.
5. If the inclination sensor is activated, the message "Edd" appears.  
For the new initialization of the tilt sensor, a reset according to chapter 5.8 must now be performed.

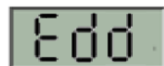

## 6 Synchronize 2 control boxes



With the SYNC-2 cable SCT (124.00183) two control boxes can be used and synchronized.

The SYNC-2 cable SCT is 4000 mm (157.5") long. It is not possible to extend the SYNC-2 cable. If necessary, the motor cables must be extended.

### 6.1 Commissioning

Initial operation of 2 control boxes	Changing from 1 control box to 2 control boxes
<ol style="list-style-type: none"> <li>1. Connect all cables to the control box according to chapter 3.2, until step 4.</li> <li>2. Connect the SYNC-2 cable to the two control boxes.</li> <li>3. Connect the hand switch to one of the control boxes.</li> <li>4. Connect the power cable to the control box.</li> <li>5. Connect the power cable to the mains.</li> <li>6. Do an initial operation according to chapter 4.</li> </ol>	<ol style="list-style-type: none"> <li>1. Reset all control boxes that were already in operation to the factory settings according to chapter 5.7.  The SYNC-2 cable SCT is installed in step 2.b.</li> </ol>

## 7 Safety strip

With lifting systems from Ergoswiss AG, care must be taken to ensure that no objects or people are trapped during a lifting movement. -> **Risk of crushing**

By attaching the safety strip to a potential pinch zone, the system stops immediately when opening or crushing the contact tube and moves back by 100 mm (3.9").

**The safety strip (124.00157) consists of:**

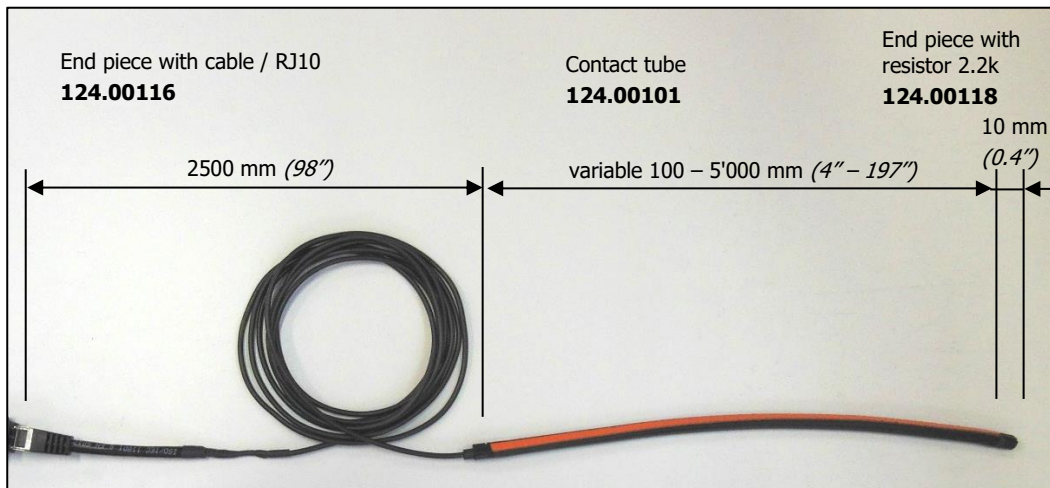

### Functional properties of the contact tube

Contact angle	< 80 °
Switching pressure	< 25 N at 23 °C
Switching travel	< 2mm at 23 °C
Bending radius minimal	B <sub>1</sub> 120 mm / B <sub>2</sub> 150 mm / B <sub>3</sub> 20 mm / B <sub>4</sub> 20 mm
Max. tensile load	20 N

### Electrical properties

Terminal resistance	2.2 kOhm
Max. switching capacity	250 mW
Max. Voltage	DC 24 V
Current min/max	1 mA / 10 mA

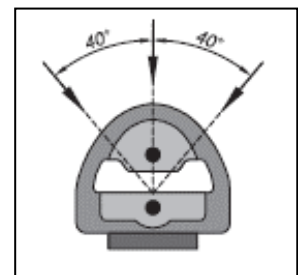
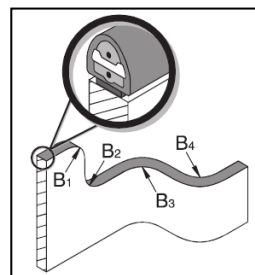

### 7.1 Commissioning

#### Gluing the contact tube in the squeeze zone

1. Clean and degrease the contact face
2. Pull off a liner of acrylic foam of 10 to 15 cm
3. Place it on the contact face and press on well
4. Repeat steps 2 and 3 until the contact tube is completely glued on
5. Maximum adhesion is reached after 24 h

#### Initial operation with the safety strip

1. Connect the safety strip to the control box according to chapter 3.2. The safety strip is connected after step 5.
2. Do an initial operation according chapter 4.

#### Adding the safety strip on existing control

1. Reset the controller to factory setting (see chapter 5.7).  
The safety strip is mounted in step 2.b.

## 8 Maintenance and disposal

---

### 8.1 Maintenance and cleaning

---

The lifting system is maintenance-free for while observing the specified normal operation.

#### ATTENTION



The control box and the manual control switch must only be cleaned with a dry or damp cloth. Before cleaning, the power cable has to be separated from the mains.

#### ATTENTION



No liquid is allowed to enter the plug connections.

### 8.2 Repairs and spare parts

---

Repairs must only be conducted by specialists. Only original replacement parts may be used. For all repair work the system must always be unloaded and voltage-free.

#### ATTENTION



In no case may the control box be opened! There is the risk of an electrical shock.

### 8.3 Disassembly and disposal

---

When decommissioning and disposing of the lifting system the electronic parts must be disposed of separately. The system consists of components that can be fully recycled and thus they are quite safe from an environmental protection perspective. The electronic parts comply with the RoHs directive.

### 8.4 Electrical and Electronic Equipment Act

---

The lifting system is not covered by the Electrical and Electronic Equipment Act (WEEE Directive 2012/19/EU), since the lifting system – in accordance with the intended purpose use – is not intended for end-users (business-to-customer) but for industrial applications (business-to-Business) is designed.

## 9 Error codes and trouble shooting

### 9.1 Error codes on the display

3-way display	Description	Trouble shooting
<b>E 60</b>	Motor voltage supply below the permissible minimum	Check power supply. Connect power cable
<b>E 61</b>	Total current has exceeded the programmed limit	System overloaded → remove load from system System jammed → remove jammed object Motor not connected correctly → connect motor cable
<b>E 62</b>	User's input is invalid (Container-Stop or Shelf-Stop cannot be set)	Container-Stop must be defined under the Shelf-Stop, or Shelf-Stop must be defined above the Container-Stop (see chapter 5.3)
<b>E 63</b>	Inconsistent or damaged Motor control parameters recognized	Reprogram the control box → Contact technical support
<b>E 64</b>	Tilt sensor has been triggered (Inclination too high)	1) Undo the tilt. (e.g. drive in the opposite direction) 2) Reset (see chapter 5.8)
<b>E 65</b>	Movement blocked (child lock)	See chapter 5.4
<b>E 66</b>	Safety strip was triggered	Remove jammed object
<b>E 69</b>	Safety strip missing	Connect or replace the safety strip
<b>E 6F</b>	Lifting movement monitoring	System overloaded → remove load from system System jammed → remove jammed object Motor not connected correctly → connect motor cable
<b>E 71</b>	Hall sensor -> wrong motor direction	Contact technical support
<b>E 73</b>	Motor missing -> no electricity	Check whether all motor cables are plugged in correctly
<b>E 74</b>	Sync cable not recognized	Check whether SYNC cables are plugged in and then reset the control box to factory settings (see chapter 5.7)
<b>E 78</b>	Overcurrent on a motor	System overloaded → remove load from system System jammed → remove jammed object Motor not connected correctly → connect motor cable
<b>E 79</b>	Sync error (Connection error)	Check whether SYNC cables are plugged in and then reset the control box to factory settings (see chapter 5.7)
<b>E 7A</b>	Position difference of the motors	Reset (see chapter 5.8)
<b>E 7C</b>	The control box has the slave role. Engine setting commands are not permitted.	Reset to factory settings (see chapter 5.7)



<b>E C9</b>	Lock -> duty cycle monitoring	The drives were operated longer than permitted. To protect against overheating, operation is blocked in the following minutes. Wait a few minutes until the drive has cooled down, then the system is ready for operation again.
<b>E CC</b>	Motor turns faster than expected by the control box	Contact technical support
<b>E D5</b>	Motor position is not transmitted to control	Connect the motor cable and then perform a reset (see chapter 5.8)
<b>E D7</b>	Short circuit on one or more motor channels	Contact technical support
<b>E D9</b>	Motor current sensor or driver defective	Contact technical support
<b>E DB</b>	User has set limits incorrectly	Contact technical support
<b>E DC</b>	Control box must be restored to factory settings	Reset to factory settings (see chapter 5.7)
<b>E DD</b>	Control box must reset	Reset (see chapter 5.8)

## 9.2 Trouble shooting

### ATTENTION



The lifting system must not be opened, reworked or operated by impermissible components.

Error	Cause	Rectification
Drive does not work	Control box not connected	Connect power cable
	Motor not connected	Connect motor cable
	Motor defective	Contact technical support
	Control box defective	Contact technical support
	Manual control switch defective	Replace the manual control switch
	Bad connector contact	Plug in all plugs correctly
Drive only move to one direction	Control box defective	Contact technical support
	Manual control switch defective	Replace the manual control switch
Drive only moves downwards	System overload	Remove weight from the system

## 10 Declaration of Incorporation

### EG-Declaration of Incorporation in the sense of the Machinery Directive 2006/42/EG annex II 1B

We hereby declare that for the incomplete machine "spindle lifting system", for ergonomically height adjustable workplaces or similar, with the variants

**Lifting system SE xxxx**  
**Frame SE-x xxxx**

**(Art. Nr. 908.41xxx)**  
**(Art. Nr. 908.51xxx)**

the following essential requirements of the Machinery Directive 2006/42/EG are applied and complied with:

**1.1.2.; 1.1.3.; 1.1.5.; 1.1.6.; 1.2.; 1.3.2.; 1.3.9.; 1.5.1.; 1.5.3.; 1.5.7.; 1.5.8.**

In particular the applied harmonized standards:

<b>EN 1005</b>	<b>Safety of machinery: Physical performance</b>
<b>EN ISO 12100</b>	<b>Safety of machinery: 2011</b>
<b>EN 60335</b>	<b>Safety of electrical appliances for household use (110V version: UL 60950)</b>
<b>EN 61000</b>	<b>Electromagnetic compatibility: EMC (110V version: FCC Part 15 Class A)</b>

specific technical documentation have been created in accordance with annex VII, part B, and will be sent to the national authorities by registered letter or electronically, if the request is justified, and this incomplete machine is in conformity with the relevant provisions of other EU Directives:

<b>89/391/EG</b>	<b>Safety and health of workers</b>
<b>2001/95/EG</b>	<b>General product safety</b>
<b>2014/30/EU</b>	<b>Directive on electromagnetic compatibility</b>
<b>2014/35/EU</b>	<b>Low voltage directive</b>

Furthermore, we declare that this incomplete machine may only be commissioned if it has been determined that the machine in which the incomplete machine is to be installed complies with the provisions of the Machinery Directive 2006/42/EG and our assembly and service operating instructions have been followed.



Widnau, 27. February  
Martin Keller  
Managing Director / CEO

Document responsibility EU:

**Ergoswiss Deutschland GmbH**  
Weiherstrasse 6/1  
DE-72585 Riederich